



United Kingdom  
Testing and  
Certification

# Test Report

The fire resistance performance of two fully insulated, timber, single acting single door assemblies when tested in accordance with BS EN 1634-1:2014+A1:2018 and three cable passthroughs tested with additional of guidance where practicable of BS EN 1366-3: 2021

Project ID 20220624-105409

Revision A

Issue Date 20 March 2023

Date of Test 17 August 2022

Prepared For Complete Fire Protection Ltd  
Unit 2 Ferry Steps Industrial Estate  
Albert Road  
Bristol  
BS2 0XW



21542



Cairnmuir House, Cairnmuir Road,  
East Kilbride, Glasgow G74 4GY  
+44 (0)1355 433 122  
info@uktestcert.com  
uktestcert.com

Trusted to ensure.

## Change History

Issue Date	Revision	Created by	Authorised by	Description of Change
20/03/2023	A	B.S.	D.F.	Initial Issue

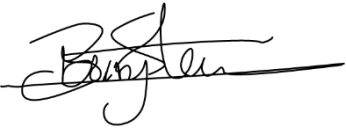
## Signatories

		
Prepared by <b>Barry Steven*</b> Technical Officer	Checked by <b>Dan Fitzsimmons*</b> Testing Manager	Authorised by <b>Andrew Hutchison*</b> Head of Technical Services

\*For and on behalf of United Kingdom Testing and Certification.

## Table of Contents

<b>1</b>	<b>Executive Summary</b> .....	<b>4</b>
1.1	Specimen Summary .....	4
1.2	Specimen Verification .....	5
1.3	Specimen Installation and Fixity .....	5
1.4	Sampling .....	5
1.5	Expression of Results .....	6
<b>2</b>	<b>Pre-test Examination</b> .....	<b>11</b>
2.1	Closing Force Measurement .....	11
2.2	Specimen Conditioning .....	11
2.3	Gap Measurements .....	12
<b>3</b>	<b>Test Specimen Drawings</b> .....	<b>14</b>
<b>4</b>	<b>Technical Schedule</b> .....	<b>21</b>
4.1	Specimen A .....	21
4.2	Specimen B .....	28
4.3	Specimen C .....	35
4.4	Specimen D .....	36
4.5	Specimen E .....	38
4.6	Supporting Construction .....	40
<b>5</b>	<b>Specimen Photographs</b> .....	<b>41</b>
<b>6</b>	<b>Test Procedure</b> .....	<b>42</b>
6.1	Heating Conditions .....	42
6.2	Pressure Conditions .....	42
6.3	Unexposed Surface Temperature .....	42
6.4	Deflection .....	43
6.5	Observations .....	45
6.6	Test Images .....	47

<b>7</b>	<b>On-going Implications .....</b>	<b>56</b>
7.1	Limitations .....	56
7.2	Accuracy of Results .....	56
7.3	European Group of Organisations for Fire Testing (EGOLF) .....	56
	<b>Figures .....</b>	<b>57</b>
	<b>Tables .....</b>	<b>61</b>
	<b>Appendix A In accordance with BS EN 1634-1:2014 +A1:2018 .....</b>	<b>72</b>
A.1	General.....	72
A.2	Materials And Construction .....	72
A.3	Permissible Size Variations.....	73
A.4	Asymmetrical Assemblies .....	75
A.5	Supporting Constructions.....	77

# 1 Executive Summary

## 1.1 Specimen Summary

Specimen A had overall nominal dimensions of 1001 mm wide by 2093 mm high, incorporating a single door leaf with overall dimensions of 930 mm wide by 2040 mm high by 45 mm thick. The door leaf was formed from cross laminated timber with 6 mm thick hardwood lippings to all four edges. The leaf was hung in a MDF frame on three steel hinges, such that it opened towards the heating conditions of the test. The doorset was latched for the duration of the test. The doors assembly incorporated the following hardware:

Item No.	Description	Reference
11	Dorma Door Closer	TS92B
14	Zoo Lockset	ZDL7260SS (Sashlock)
15	Zoo Cylinder with thumbturn	V10 – High Secure 3*
16	Zoo Lever Handles	ZCS030SS
17	Zoo Escutcheon	ZCS20011SS

Specimen B had overall nominal dimensions of 1021 mm wide by 2104 mm high, incorporating a single door leaf with overall dimensions of 930 mm wide by 2040 mm high by 44 mm thick. The door leaf was formed from graduated density chipboard with 6 mm thick hardwood lippings to all four edges. The leaf was hung in a hardwood frame on three steel hinges, such that it opened towards the heating conditions of the test. The doorset was latched for the duration of the test. The doors assembly incorporated the following hardware:

Item No.	Description	Reference
29	Dorma Door Closer	TS92B
32	ERA Multipoint Lock	DLSF 4560985B (SureFire Classic 2)
33	ERA Cylinder with thumbturn	3* 13010C6D
34	ERA Lever Handles	Windsor Sprung Lever

Specimen C had overall nominal dimensions of 355 mm diameter, incorporating a single door hatch with overall dimensions of 350 mm diameter by 2 mm thick. The specimen included a smoke sock for passing through cables and was inserted into a pipe penetration with overall dimensions of 250mm diameter by 132 mm long. The door hatch was hung such that it opened away the heating conditions of the test.

Specimen D had overall nominal dimensions of 305 mm diameter, incorporating a single door hatch with overall dimensions of 300 mm diameter by 2 mm thick. The specimen included a smoke sock for passing through cables and was inserted into a pipe penetration with overall dimensions of 200 mm diameter by 132 mm long. The door hatch was hung such that it opened away the heating conditions of the test.

Specimen E had overall nominal dimensions of 205 mm diameter, incorporating a single door hatch with overall dimensions of 200 mm diameter by 2 mm thick. The specimen included a smoke sock for passing through cables and was inserted into a pipe penetration with overall dimensions of 175 mm diameter by 132 mm long. The door hatch was hung such that it opened away the heating conditions of the test.

## 1.2 Specimen Verification

United Kingdom Testing and Certification carried out a comprehensive survey to verify the information provided by the Test Sponsor. This included verifying the materials, dimensions, and manufacturing methodologies of the test specimens, wherever possible. Refer to page 21 for full details of this survey.

## 1.3 Specimen Installation and Fixity

Specimen A was installed into the test construction by United Kingdom Testing and Certification. The specimen was installed such that the door leaf opened towards the heating conditions at the request of the Test Sponsor. The specimen was latched but unbolted prior to the commencement of the test at the request of the test sponsor.

Specimen B was installed into the test construction by United Kingdom Testing and Certification. The specimen was installed such that the door leaf opened towards the heating at the request of the Test Sponsor. The specimen was latched but unbolted prior to the commencement of the test at the request of the test sponsor.

## 1.4 Sampling

United Kingdom Testing and Certification were not involved in the sampling or selection of the test specimen or any of the components. The results obtained during the test apply to the specimens as received and test by United Kingdom Testing and Certification.

## 1.5 Expression of Results

### 1.5.1 Specimen A

Specimen A satisfied the performance criterion specified in BS EN 1634-1:2014+A1:2018 § 11 for the following intervals:

<b>Integrity (E)<sup>1</sup></b>	Sustained Flaming	38 minutes	No failure*
	Gap Gauge	38 minutes	No failure*
	Cotton Pad	38 minutes	No failure*
<b>Insulation (I<sub>1</sub>)<sup>2</sup></b>		38 minutes	No failure*
<b>Insulation (I<sub>2</sub>)<sup>3</sup></b>	Specimen	38 minutes	No failure*

\*The specimen was blanked off after a period of 38 minutes.

---

<sup>1</sup> The time(s) in completed minutes for which the test specimen(s) continues to maintain its separating function without: a) causing ignition to the cotton pad applied in accordance with BS EN 1363-1:2020 § 10.4.5.2 b) permitting the penetration of a gap gauge as specified in EN 1363-1:2020 § 10.4.5.3 c) resulting in sustained flaming.

<sup>2</sup> The time(s) in completed minutes for which the test specimen(s) continues to maintain its separating function without developing temperatures on its unexposed surface which increase at the locations specified in BS EN 1634-1:2014+A1:2018 § 9.1.2.2, 9.1.2.3, 9.1.2.4 and the roving thermocouple above the initial average temperature by more than 180°C.

<sup>3</sup> The time(s) in completed minutes for which the test specimen(s) continues to maintain its separating function without developing temperatures on its unexposed surface which: a) increase the average temperature above the initial average temperature by more than 140 °C; b) increase at any location (including the roving thermocouple) above the initial average temperature by more than 180°C with the exception that the limit for temperature rise for any frame member or transom member adjacent to the leaf/leaves of the doorset or openable window shall be 360°C.

### 1.5.2 Specimen B

Specimen B satisfied the performance criterion specified in BS EN 1634-1:2014+A1:2018 § 11 for the following intervals:

<b>Integrity (E)<sup>4</sup></b>	Sustained Flaming	55 minutes	No failure*
	Gap Gauge	55 minutes	No failure*
	Cotton Pad	55 minutes	No failure*
<b>Insulation (I<sub>1</sub>)<sup>5</sup></b>		55 minutes	No failure*
<b>Insulation (I<sub>2</sub>)<sup>6</sup></b>	Specimen	55 minutes	No failure*

\*The specimen was blanked off after a period of 55 minutes.

<sup>4</sup> The time(s) in completed minutes for which the test specimen(s) continues to maintain its separating function without: a) causing ignition to the cotton pad applied in accordance with BS EN 1363-1:2020 § 10.4.5.2 b) permitting the penetration of a gap gauge as specified in EN 1363-1:2020 § 10.4.5.3 c) resulting in sustained flaming.

<sup>5</sup> The time(s) in completed minutes for which the test specimen(s) continues to maintain its separating function without developing temperatures on its unexposed surface which increase at the locations specified in BS EN 1634-1:2014+A1:2018 § 9.1.2.2, 9.1.2.3, 9.1.2.4 and the roving thermocouple above the initial average temperature by more than 180°C.

<sup>6</sup> The time(s) in completed minutes for which the test specimen(s) continues to maintain its separating function without developing temperatures on its unexposed surface which: a) increase the average temperature above the initial average temperature by more than 140 °C; b) increase at any location (including the roving thermocouple) above the initial average temperature by more than 180°C with the exception that the limit for temperature rise for any frame member or transom member adjacent to the leaf/leaves of the doorset or openable window shall be 360°C.



### 1.5.3 Specimen C

Specimen C satisfied the performance criterion specified in BS EN 1366-3 § 11 for the following intervals:

Integrity (E) <sup>7</sup>	Sustained Flaming	91 minutes	Area blanked off
	Gap Gauge	91 minutes	Area blanked off
	Cotton Pad	86 minutes	
Insulation (I) <sup>8</sup>		29 minutes	Exceeded maximum temperature criteria @TC36

\*The test was discontinued after a period of 135 minutes.

<sup>7</sup> The time(s) in completed minutes for which the test specimen(s) continues to maintain its separating function without: a) causing ignition to the cotton pad applied in accordance with BS EN 1363-1:2020 § 10.4.5.2 b) permitting the penetration of a gap gauge as specified in EN 1363-1:2020 § 10.4.5.3 c) resulting in sustained flaming.

### 1.5.4 Specimen D

Specimen D satisfied the performance criterion specified in BS EN 1366-3 § 11 for the following intervals:

Integrity (E) <sup>9</sup>	Sustained Flaming	135 minutes	No failure*
	Gap Gauge	135 minutes	No failure*
	Cotton Pad	135 minutes	No failure*
Insulation (I) <sup>10</sup>	Specimen	125 minutes	Exceeded maximum temperature criteria @TC41

\*The test was discontinued after a period of 135 minutes.

<sup>9</sup> The time(s) in completed minutes for which the test specimen(s) continues to maintain its separating function without: a) causing ignition to the cotton pad applied in accordance with BS EN 1363-1:2020 § 10.4.5.2 b) permitting the penetration of a gap gauge as specified in EN 1363-1:2020 § 10.4.5.3 c) resulting in sustained flaming.

<sup>10</sup> The time(s) in completed minutes for which the test specimen(s) continues to maintain its separating function without developing temperatures on its unexposed surface which: a) increase at any location (including the roving thermocouple) above the initial individual temperature by more than 180°C. as specified in EN 1366-3:2021 § 11.2

### 1.5.5 Specimen E

Specimen E satisfied the performance criterion specified in BS EN 1366-3 § 11 for the following intervals:

Integrity (E) <sup>11</sup>	Sustained Flaming	135 minutes	No failure*	
	Gap Gauge	135 minutes	No failure*	
	Cotton Pad	135 minutes	No failure*	
Insulation (I) <sup>12</sup>	Specimen	134 minutes	Exceeded maximum temperature criteria	@TC46

\*The test was discontinued after a period of 135 minutes.

<sup>11</sup> The time(s) in completed minutes for which the test specimen(s) continues to maintain its separating function without: a) causing ignition to the cotton pad applied in accordance with BS EN 1363-1:2020 § 10.4.5.2 b) permitting the penetration of a gap gauge as specified in EN 1363-1:2020 § 10.4.5.3 c) resulting in sustained flaming.

<sup>12</sup> The time(s) in completed minutes for which the test specimen(s) continues to maintain its separating function without developing temperatures on its unexposed surface which: a) increase at any location (including the roving thermocouple) above the initial individual temperature by more than 180°C. as specified in EN 1366-3:2021 § 11.2

## 2 Pre-test Examination

### 2.1 Closing Force Measurement

The door closing forces were measured and recorded three times. The results are presented below:

Measurement	Maximum Recorded Force (N)	Distance from Pivot to Measurement Location (m)	Moment (Nm)
Closing Force Specimen A	22.8	0.750	17.1
Opening Force Specimen A	63.6	0.750	47.7
Closing Force Specimen B	19.0	0.750	14.25
Opening Force Specimen B	61.0	0.750	45.75

### 2.2 Specimen Conditioning

The specimen's storage, construction, and test preparation took place in the test laboratory over a total, combined time of two days. Throughout this period, both the temperature and the humidity of the laboratory were measured and recorded as being within a range of from 19.7 °C to 20.0 °C and 70.2 % to 72.9 % respectively.

### 2.3 Gap Measurements

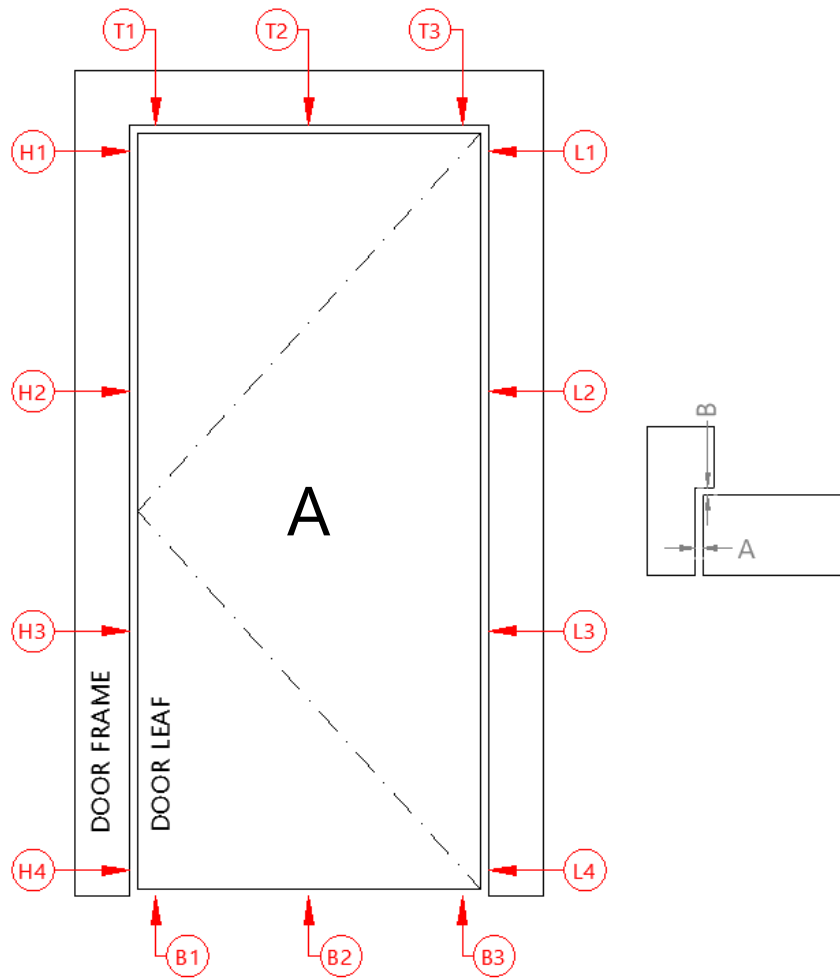

Hanging Stile	A	B	Closing Stile	A	B
H1	1.7	4.0	L1	0.5	9.7
H2	2.4	4.0	L2	1.1	9.8
H3	1.2	3.0	L3	1.3	9.8
H4	0.9	3.0	L4	0.9	8.6
<b>Mean</b>	<b>1.6</b>	X	<b>Mean</b>	<b>0.9</b>	X
<b>Max</b>	<b>2.4</b>		<b>Max</b>	<b>1.3</b>	
<b>Min</b>	<b>0.9</b>		<b>Min</b>	<b>0.5</b>	
<b>Max Permitted</b>	<b>4.0</b>		<b>Max Permitted</b>	<b>3.1</b>	
<b>Top Edge</b>	<b>A</b>	<b>B</b>	<b>Bottom Edge</b>	<b>A</b>	
T1	3.0	8.7	B1	2.4	
T2	1.4	8.4	B2	0.8	
T3	1.0	9.5	B3	1.9	
<b>Mean</b>	<b>1.8</b>	X	<b>Mean</b>	<b>1.7</b>	
<b>Max</b>	<b>3.0</b>		<b>Max</b>	<b>2.4</b>	
<b>Min</b>	<b>1.0</b>		<b>Min</b>	<b>0.8</b>	
<b>Max Permitted</b>	<b>4.4</b>		<b>Max Permitted</b>	<b>4.1</b>	

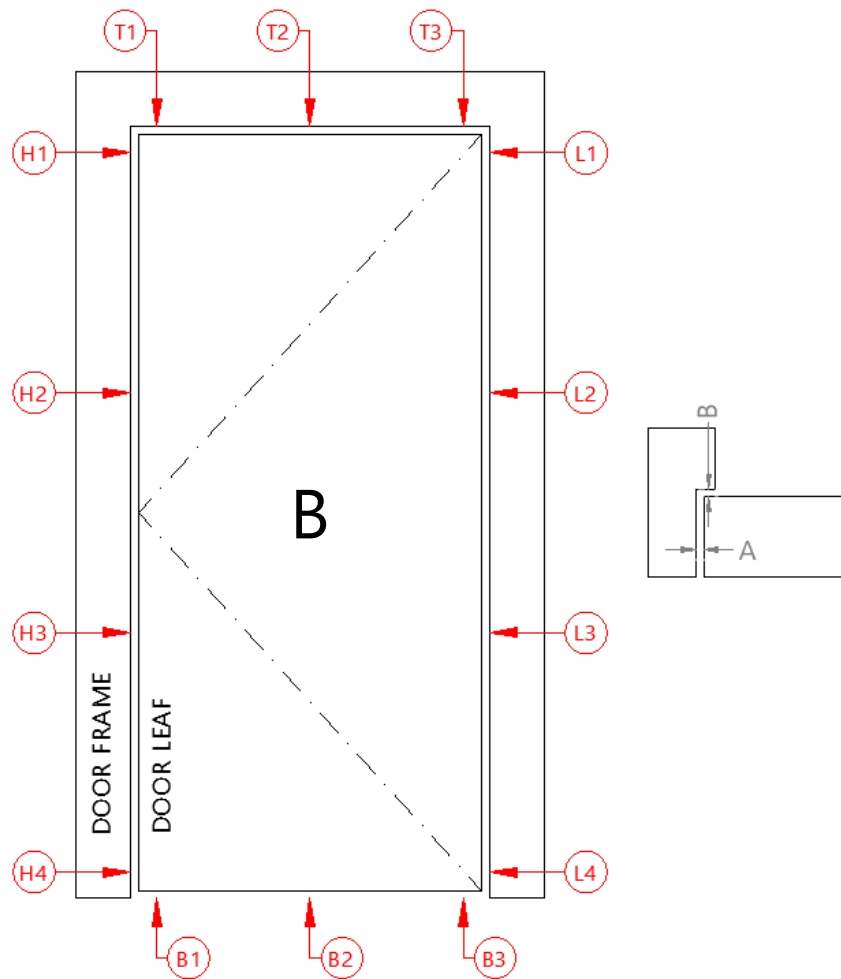

Hanging Stile	A	B	Closing Stile	A	B
H1	2.8	0.1	L1	8.6	1.7
H2	2.1	0.5	L2	8.1	0.2
H3	2.4	0.1	L3	8.1	0.4
H4	2.0	1.1	L4	8.7	0.1
Mean	2.3	X	Mean	8.4	X
Max	2.8		Max	8.7	
Min	2.0		Min	8.1	
Max Permitted	4.6		Max Permitted	10.5	
<b>Top Edge</b>	<b>A</b>	<b>B</b>	<b>Bottom Edge</b>	<b>A</b>	
T1	8.2	0.5	B1	14.6	
T2	8.6	1.1	B2	13.0	
T3	9.3	2.2	B3	14.7	
Mean	8.7	X	Mean	14.1	
Max	9.3		Max	14.7	
Min	8.2		Min	13.0	
Max Permitted	11.0		Max Permitted	16.4	

### 3 Test Specimen Drawings

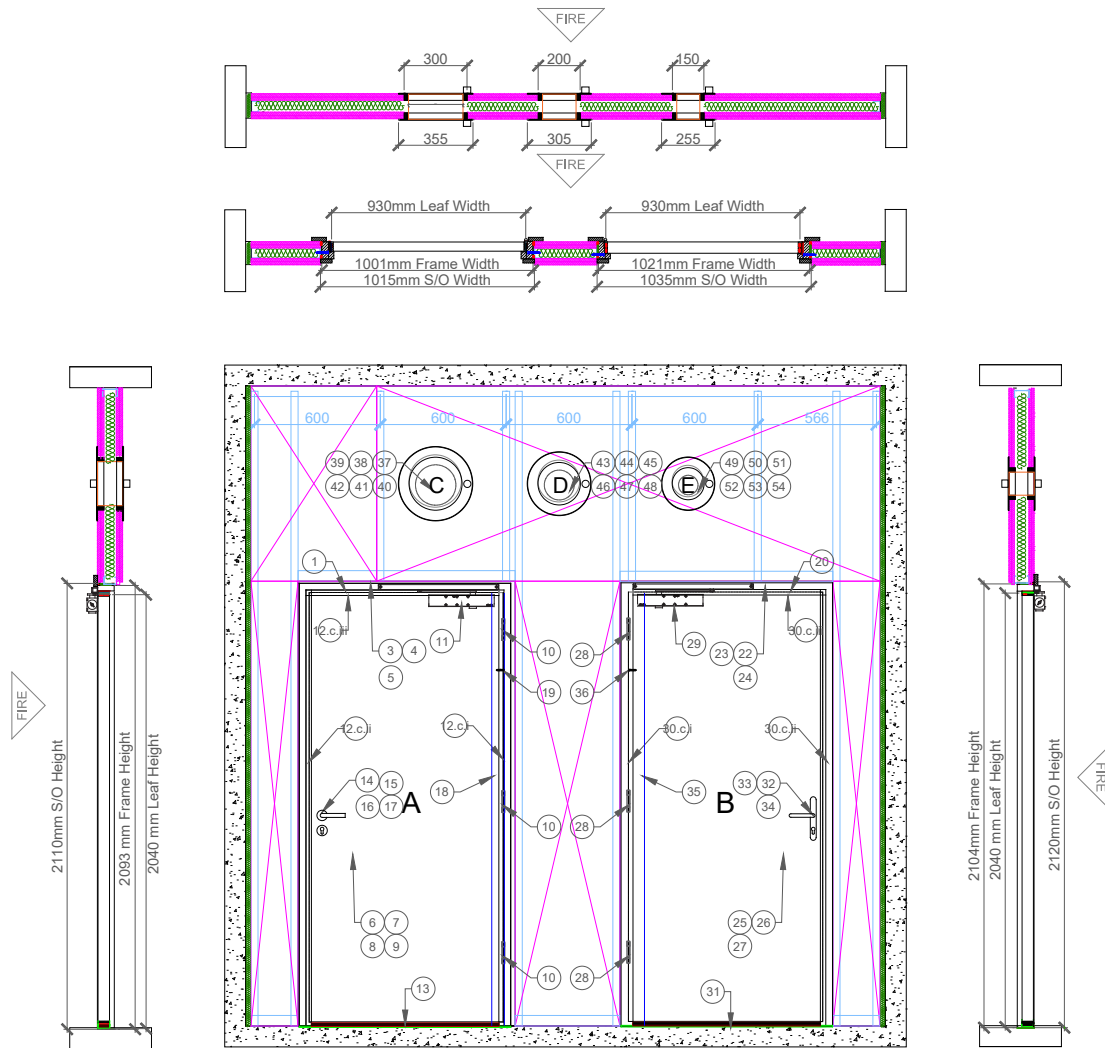

Figure 1 - General arrangement of test construction viewed from the unexposed surface

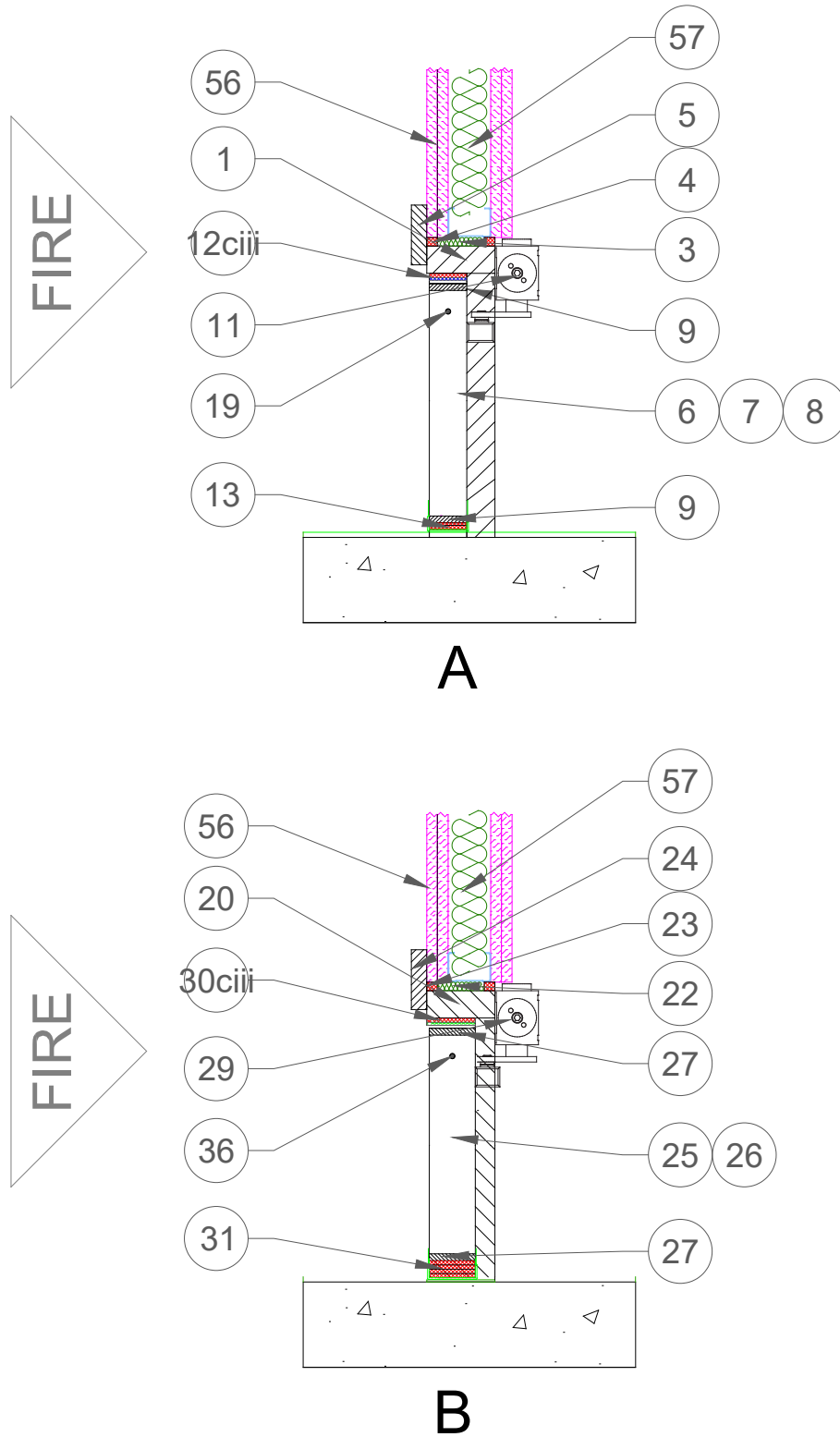

Figure 2 - Typical vertical section through the specimens



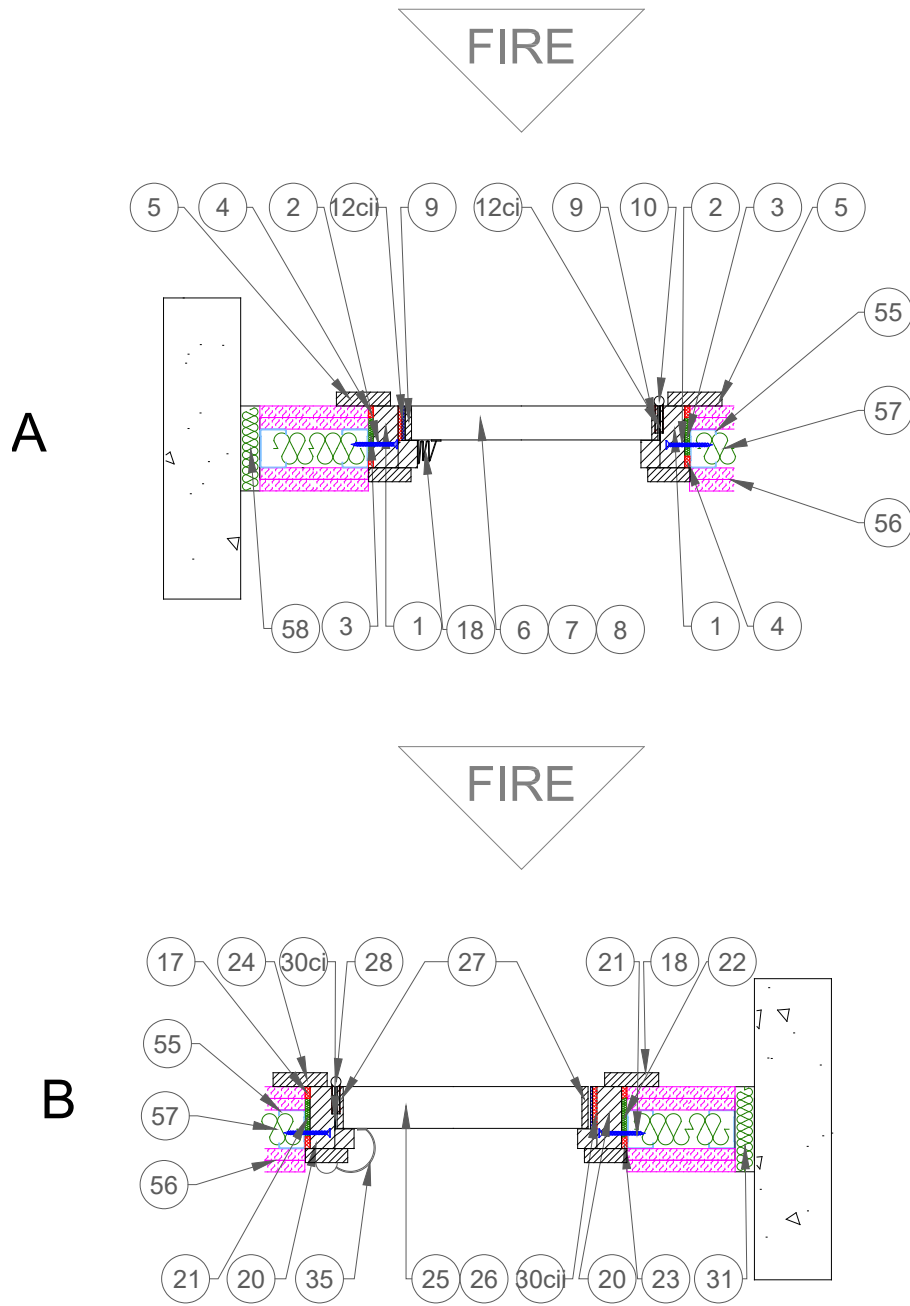
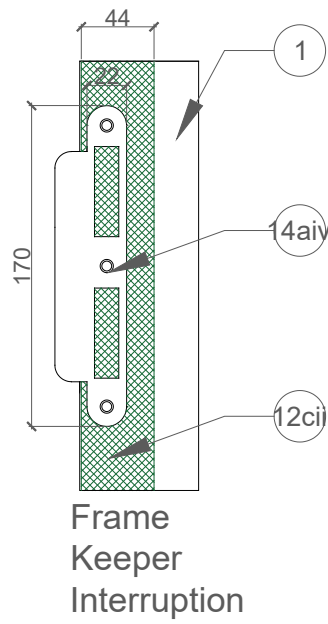

Figure 3 - Typical horizontal section through the specimens

# A



# B

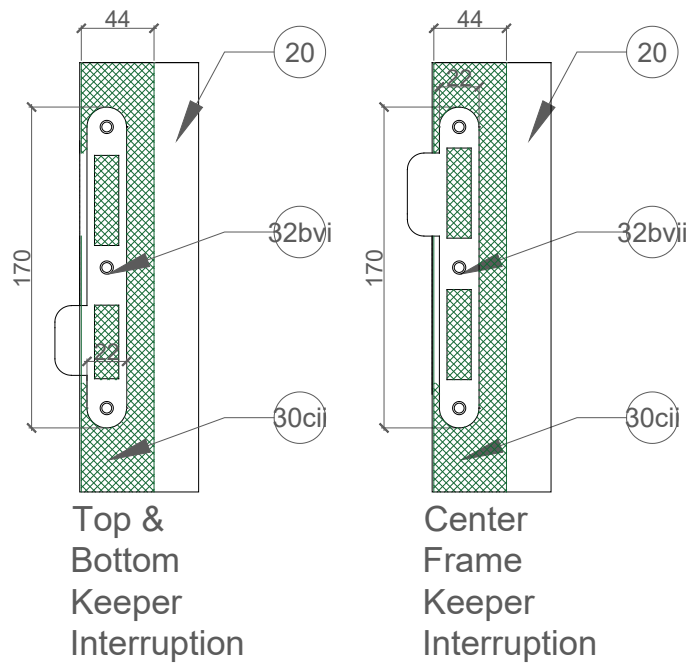
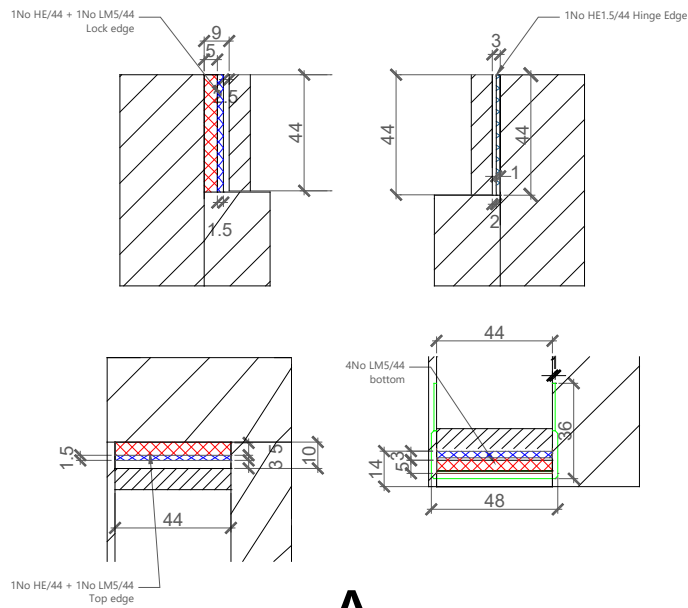
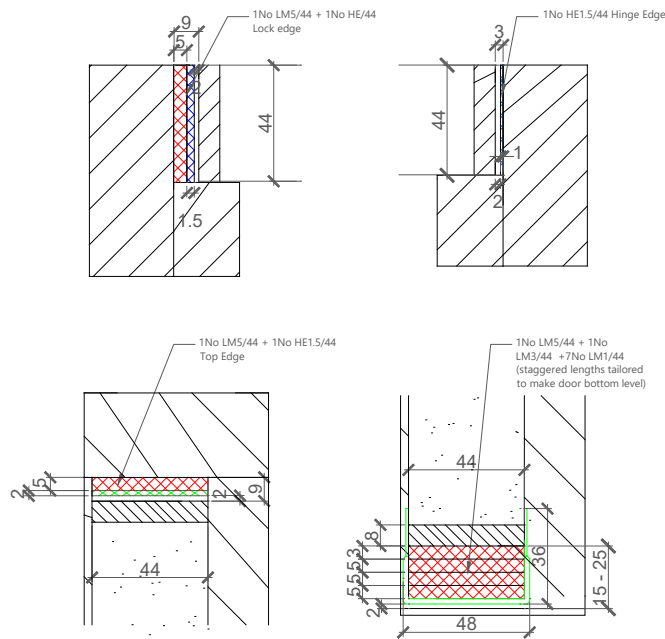

Figure 4 - Hardware intumescent interruptions



A



B

Figure 5 – FrameFit Details

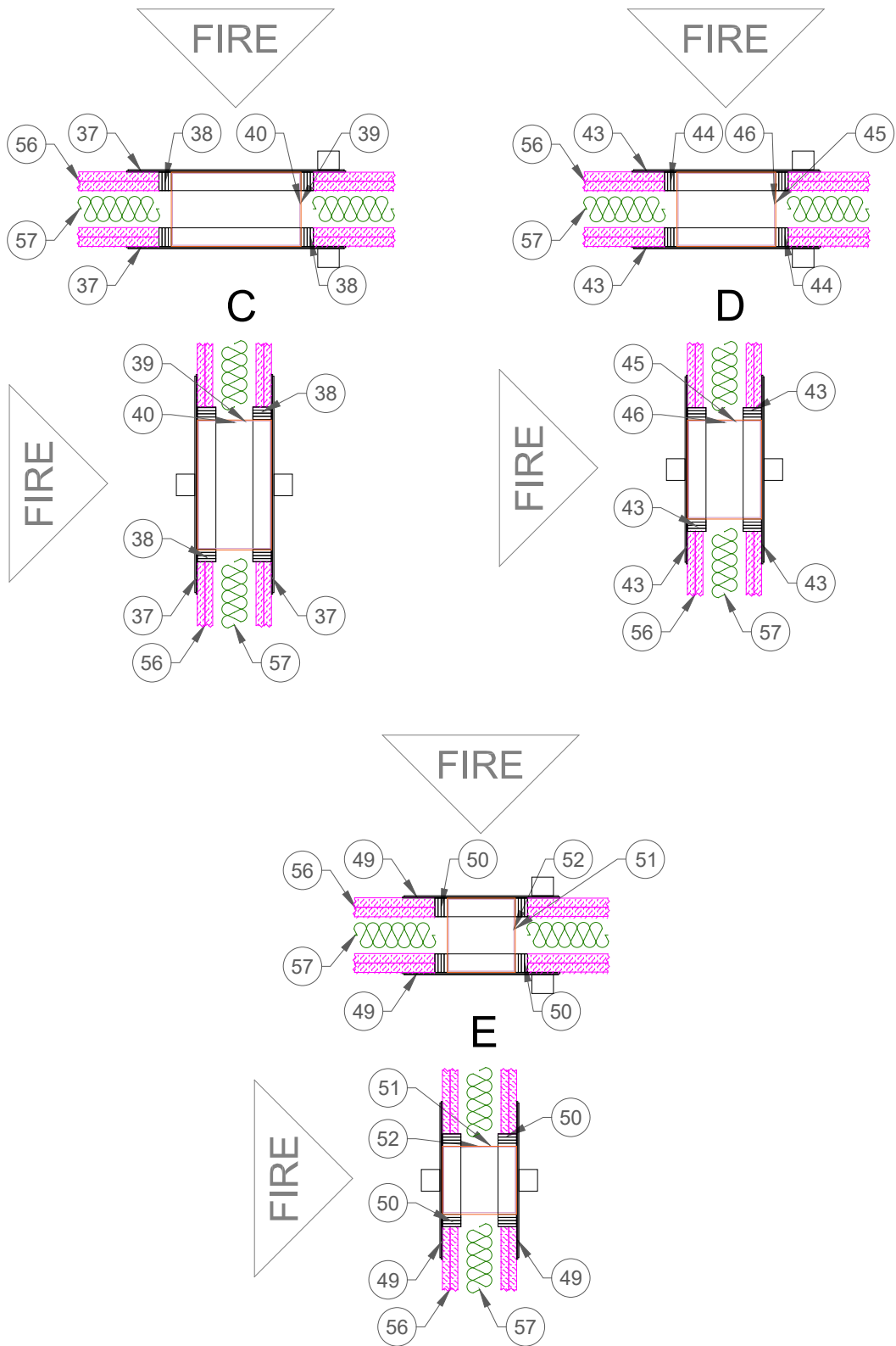

Figure 6 – Fire Plug Cross Sections

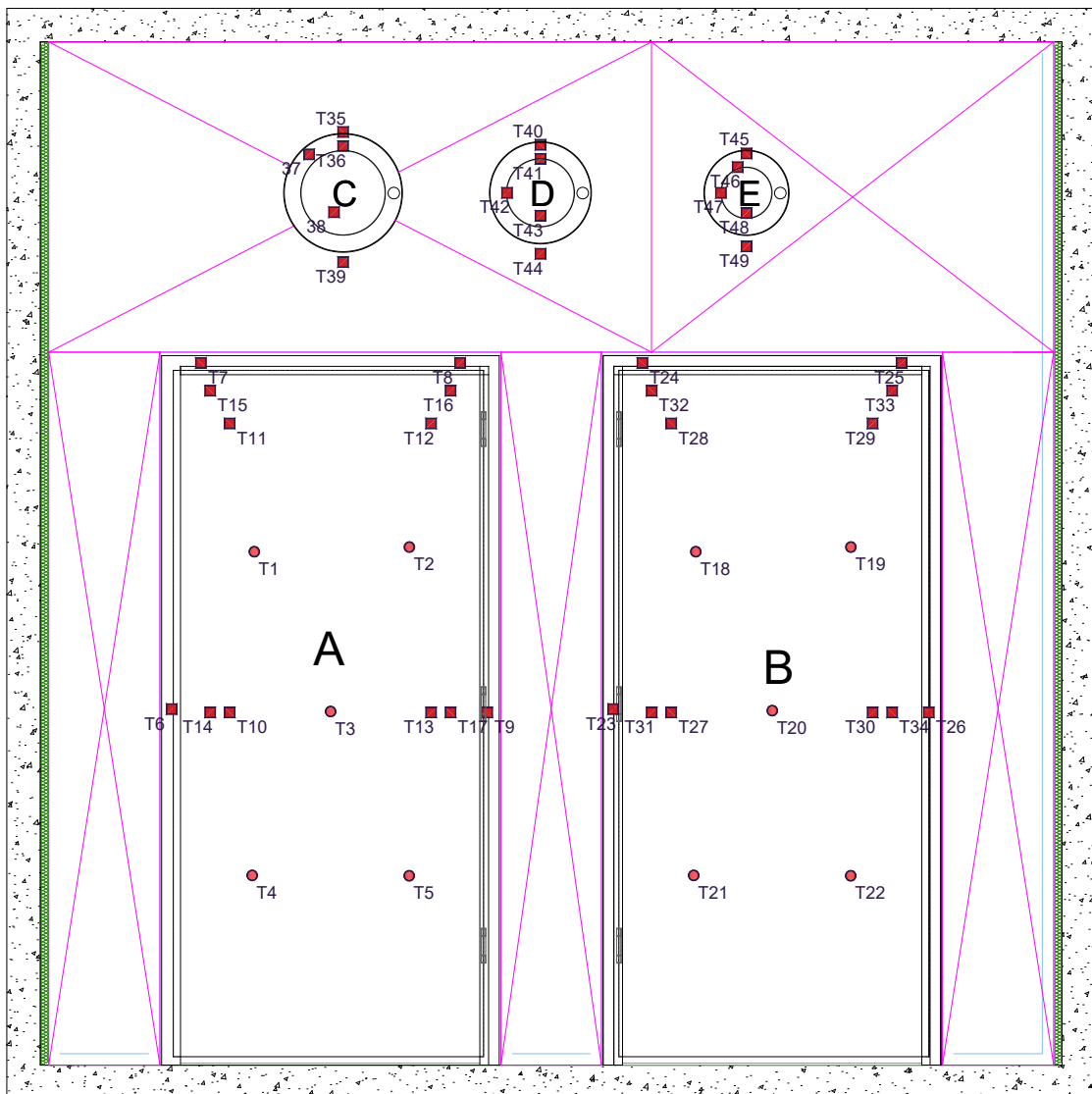

Figure 7 - Layout of instrumentation viewed from the unexposed surface of the test construction

## 4 Technical Schedule

All dimensions are in millimetres (mm) unless otherwise stated.

\* Information provided by the Test Sponsor. Not verified by United Kingdom Testing and Certification.

\*\* Nominal value.

\*\*\* Information is commercial in confidence. Full details are retained on file by United Kingdom Testing and Certification.

### 4.1 Specimen A

1. Frame	
Manufacturer	S A Joinery
Reference	MDF FD 30
Material	MDF Head and MDF Jambs
Density	690 kg/m <sup>3</sup> *
Moisture content	6.0 – 6.4 % (laboratory measurement)
a. Overall size	1001 mm wide x 2093 mm high
i. Frame (Head)	72 mm wide x 30 mm thick
ii. Frame (Jambs)	72 mm wide x 30 mm thick
Stop	25 mm wide x 20 mm deep
Jamb to Head jointing method, fixing detail and location	10 mm Trench with 2 no. off Ø 5 mm x 100 mm long wood screw, Glued D4 PVA
Stop to Frame jointing method, fixing detail and location	Pinned with Ø 1.6 x 38 mm brad nails at 450 mm centres
b. Adhesive(s)	
i. Manufacturer	Ever build
ii. Type	D4 PVA
iii. Reference	EN204
iv. Curing method	Air
v. Application method	Squeezed & brushed
2. Frame Fixing Method to Supporting Construction	
Manufacturer	Turbo Outdoor
Reference	3917X
Type & material	Carbon Steel PZ double countersunk screws

Overall size	Ø 5 mm x 80 mm long
Spacing	150 mm from top corner of jamb, 150 mm from bottom corner of jamb and at no more than 600 mm centres
Does the fixing penetrate intumescent seal within frame reveal	N/a
Packing Material	Certitek PVC U Shims
Packing Material Dimension	101 mm x 43 mm assorted thicknesses
Packing Material Location	At each fixing location
<b>3. Frame to supporting construction fire stopping detail</b>	
Manufacturer	Saint-Goban Isover
Reference	Acoustic Partition Roll
Material	Glass Mineral Wool
Overall dimension	4–10 mm x 50 mm deep
Application method	Friction fitted into gaps between the supporting construction and frame
<b>4. Sealant to fire stopping detail</b>	
Manufacturer	Certitek
Reference	DM-01 Intumescent & Acoustic Acrylic Sealant
Material	Acrylic Sealant
Overall section size	10 mm deep x 2 mm to 10 mm wide
Application method	Using a cartridge gunned
Location	Gaps between the head and jambs and supporting construction
<b>5. Architrave</b>	
Manufacturer	S A Joinery
Material	MDF
Overall section size	70 mm x 18 mm
Location	6 mm Back from inside edge (Fire side)
Application method, fixings and fixing frequency required	PVA D4 Glued & Pinned 1.5 x 38 gas fired nails
<b>6. Door Leaf</b>	
Supplier	Halspan
Reference	IT 30

Quantity of leaves on doorset	1
Glazing location relative to the head and closing edge	N/A
Overall leaf size supplied for testing	2040 mm wide x 930 mm high x 45 mm thick
<b>7. Core element</b>	
Manufacturer	Halspan
Reference	Cross laminated timber lamels
Material	Spruce/pine
Location	Centre of construction
Density	450 kg/m <sup>3</sup> *
Overall thickness and reduced thickness if door leaf incorporates fielded areas	3 no. layers of 12 mm thick
Application method	Bonded
a. Adhesives	Not declared
b. Presence of Mechanical Fixings	Not declared
<b>8. Facings</b>	
Manufacturer	SA Joinery
Material	MDF
Location	Applied to both faces of Core element
Density	720 kg/m <sup>3</sup> *
Overall thickness and reduced thickness if door leaf incorporates fielded areas	4.5 mm thick
a. Adhesives	Not declared
b. Presence of Mechanical Fixings	Not declared
<b>9. Lippings / Edge banding</b>	
Manufacturer	S A Joinery
Material	Sapele
Density	640 kg/m <sup>3</sup> *
Moisture content	9.1 – 10.2 % (laboratory measurement)
Overall size	6 mm x 45 mm x length of door
Fixing method	Glued



Location	All Edges
a. Adhesives	
i. Manufacturer	UREKA
ii. Type	PU
iii. Reference	AREO BOND 947
iv. Curing method	Moisture
v. Application method	Roller
b. Presence of Mechanical Fixings	N/A
<b>10. Hinges</b>	
Supplier	Royde and Tucker Manufacturing
Reference	H102
Quantity	3 no.
Primary material	Steel
Type	Ball Butt Bearing
a. Size	
i. Knuckle	Ø 14 mm x 104 mm high
ii. Blades	100 mm high x 35 mm wide x 3 mm thick
b. Fixings	
i. Type	Countersunk wood screws
ii. Material	Stainless Steel
iii. Size	Ø 5 mm x 32 mm long
iv. Number off per blade	5 no.
Position of each hinge relative to the head of the leaf	1 <sup>st</sup> - 170 mm, 2 <sup>nd</sup> – 945 mm, 3 <sup>rd</sup> – 1712 mm
Details of intumescent protection	1mm Interdens (VANQUISH)
Interruptions to Intumescent within the frame reveal	Framefit fireplug sits over the hinges.
<b>11. Door Closer</b>	
Manufacturer	DORMA
Reference	TS92B
a. Material	

i. Body	Mild Steel
ii. Closer arm	Stainless Steel
iii. Cover	Stainless Steel
Configuration	Cam. Action Slide Arm
b. Overall size	
i. Slide arm	524 mm wide x 22 mm thick x 33 mm deep
ii. Body	281 mm high x 65 mm wide x 47 mm deep
iii. Cover	56 mm high x 296 mm wide x 0.5 mm deep
Fixing method	Screwed with 4 no Ø 5 mm x 50 mm stainless steel screws
<b>12. Fireplug Framefit System Details</b>	
Manufacturer	Complete Fire Protection Ltd
Reference	Fireplug FrameFit System for 30-minute fire doors - Ref FF30
Material	Low modulus fire retardant graphite intumescent
a. System Components	
i. Gap spacers (LM Range for 30-minute doors)	Low Modulus (LM) fire retardant intumescent Ref: LM1.5/44, LM3/44, LM5/44
ii. Hinge Side (HE44 for 30-minute doors)	High expansion intumescent Ref: HE44
b. Overall Size	
i. LM/44 Range	44 mm wide x 2100 mm long x 1.5/3/5 mm thick
ii. HE44	44 mm wide x 2100 mm long x 1.5 mm thick
iii. Application Method	Fix required LM profiles to the door frame opposite the door edges by using the double-sided adhesive tape found on the reverse side of each profile. Once the correct number of LM profiles are in place, pin fix through all layers into the door frame using a minimum of 20 mm long panel pins at seal ends. The HE44 is generally used on the hinged side only. It is fitted using the double-sided adhesive tape found on the reverse side of each profile.
c. Door Edge Gap sizes	<b>FrameFit Configuration</b>
i. Hinge (3 mm gap)	1No HE/44
ii. Leading edge (9 mm gap)	1No HE/44 + 1No LM5/44
iii. Top Edge (10 mm gap)	1No HE/44 + 1No LM5/44

13. Fireplug Framefit Bottom	
Manufacturer	Complete Fire Protection Ltd
Reference	Fireplug Framefit - for 30-minute doors
Material	Low modulus fire retardant graphite intumescent
Overall section size	As LM Range Build up held within a 48 mm wide x 18 mm high metal channel.
Location (relative to the opening face of the door leaf)	Located on the bottom door edge
Application Method	Fix required LM profiles to the bottom door edge by using the double-sided adhesive tape found on the reverse side of each profile. Once the correct number of LM profiles are in place, encase the profiles with the appropriate BDS cover strip. Then screw/pin fix through all layers into the bottom of the door edge using a minimum of 40 mm long screws/panel pins at approximately 350 mm centres ensuring screws/pins penetrate door edge by minimum of 10 mm.
Door Edge Gaps	<b>FrameFit configuration</b>
Bottom of leaf (14 mm gap)	1No LM3/44 + 1No LM5/44 gap at the bottom of the specimen in relation to the restraint frame
14. Lockset / Latch	
Manufacturer	Zoo
Reference	ZDL7260SS (Sashlock)
a. Material	
i. Lockcase	Mild Steel
ii. Forend plate	Stainless Steel
iii. Lock bolt	Stainless Steel
iv. Keeper	Stainless Steel
b. Overall sizes	
i. Central Lockcase	165 mm high x 85 mm wide x 82 mm deep
ii. Forend plate	235 mm high x 22 mm wide x 3 mm thick
iii. Lock bolt	35 mm high x 9 mm wide x 20 mm projection
iv. Keeper	180 mm high x 24 mm wide x 1.5 mm thick with a 135 mm high x 15 mm wide Tongue
Fixing method	2No. Ø 4 x 20 mm CSK woodscrews
Operation of lock bolt	Engaged

c. Details of intumescent protection	
i. Central Lockcase	1mm Flex Fire (VANQUISH)
ii. Forend plate	1mm Flex Fire (VANQUISH)
iii. Keeper	1mm Flex Fire (VANQUISH)
Location of centre of the spindle relative to the bottom of the leaf	Centre of the spindle measures 1000 mm from the bottom of the leaf
<b>15. Cylinder with thumbturn</b>	
Manufacturer	ZOO
Reference	V10 - High Secure 3*
Material	Satin Chrome Plated
Overall size	17 mm wide x 33 mm high x 70 mm long
<b>16. Lever handles</b>	
Manufacturer	ZOO
Reference	ZCS030SS
Material	Satin Stainless steel
a. Overall size	
i. Rose	Ø 52 mm x 8 mm thick
ii. Handle	Ø 19 mm x 140 mm long x 55 mm projection
Fixing method, fixing material, sizes, quantity and location	4no. Ø 3.5 mm x 25 mm long wood screws & 2no. Ø 4 mm bolt through fixings.
<b>17. Escutcheon</b>	
Manufacturer	ZOO
Reference	ZCS20011SS
Material	Satin Stainless steel
Overall size	Ø 52 mm x 8 mm thick
Location	925 mm from bottom of door to centre.
Fixing method	4no 2.5 mm x 25 mm long wood screws.

18. Plastic Finger Guard	
Manufacturer	RAM Extrusions
Reference	Digitex Front Finger Guard
Material	Plastic
Overall size	65 mm wide x 1970 mm high x 2 mm thick
Location	Unexposed stop face of doorset on the hung edge of the door.
Fixing method	12 no 3.5 mm x 25 mm long wood screws @ approx. 150mm centres.
19. Door Pin ID Tag	
Manufacturer	Door Data Systems
Reference	FrameFit DDP
Material	Information chip & plastic
Overall size	Ø 6 mm x 37.5 mm long
Location	Top of hinge side
Fixing method	Friction fitted into door edge.

## 4.2 Specimen B

20. Frame	
Manufacturer	S A Joinery
Reference	FD30
Material	Sapele
Density	640 kg/m <sup>3</sup> *
Moisture content	11.2 – 12.1 % (laboratory measurement)
a. Overall size	2104 mm high x 1021 mm wide x 80 mm wide
i. Frame (Head)	72 mm wide x 32 mm thick
ii. Frame (Jambs)	72 mm wide x 32 mm thick
iii. Stop	25 mm wide x 25 mm deep
Jamb to Head jointing method, fixing detail and location	Stub Tenon 2no. off Ø 5 mm x 100 mm long wood screw
Stop to Frame jointing method, fixing detail and location	1.5 mm x 50 mm Gas fired pins @ 200 mm centres

b. Adhesive(s)	
i. Manufacturer	Ever build
ii. Type	D4 PVA
iii. Reference	EN204
iv. Curing method	Air
v. Application method	Squeezed & brushed
<b>21. Frame Fixing Method to Supporting Construction</b>	
Manufacturer	Turbo Outdoor
Reference	3917X
Type & material	Carbon Steel PZ double countersunk screws
Overall size	Ø 5 mm x 80 mm long
Spacing	150 mm from top corner of jamb, 150 mm from bottom corner of jamb and at no more than 600 mm centres
Does the fixing penetrate intumescent seal within frame reveal	N/a
Packing Material	Certitek PVC U Shims
Packing Material Dimension	101 mm x 43 mm assorted thicknesses
Packing Material Location	At each fixing location
<b>22. Frame to supporting construction fire stopping detail</b>	
Manufacturer	Saint-Gobain
Reference	Isover Insulation
Material	Mineral Wool
Overall dimension	50 mm deep x 2 mm to 10 mm wide
Application method	Compression fitted
<b>23. Sealant to fire stopping detail</b>	
Manufacturer	Certitek
Reference	DM-01 Intumescent & Acoustic Acrylic Sealant
Material	Acrylic Sealant
Overall section size	10 mm deep x 2 mm to 10 mm wide
Application method	Using a cartridge gunned
Location	Gaps between the head and jambs and supporting construction

24. Architrave	
Manufacturer	S A Joinery
Material	MDF
Overall section size	70 mm x 18 mm
Location	6 mm Back from inside edge (Fire side)
Application method, fixings and fixing frequency required	PVA D4 Glued & Pinned 1.5 x 38 gas fired nails
25. Door Leaf	
Supplier	S A Joinery
Reference	Prima
Quantity of leaves on doorset	1
Glazing location relative to the head and closing edge	N/a
Overall leaf size supplied for testing	2040 mm high x 930 mm wide x 44 mm thick
26. Core element	
Manufacturer	Halspan
Reference	Prima
Material	Graduated Density Chipboard
Density	630 kg/m <sup>3</sup> *
Overall thickness	44 mm thick
27. Lippings / Edge banding	
Manufacturer	S A Joinery
Reference	Lipping
Material	Sapele
Density	640 kg/m <sup>3</sup> *
Moisture content	9.5 – 10.1 % * (laboratory measurement)
Overall size	6mm x 44mm x length of door
Fixing method	Glued
Location	All Edges
a. Adhesives	

i. Manufacturer	UREKA
ii. Type	PU
iii. Reference	AREO BOND 947
iv. Curing method	Moisture
v. Application method	Roller
b. Presence of Mechanical Fixings	No
<b>28. Hinges</b>	
Supplier	Royde and Tucker Manufacturing
Reference	H102
Quantity	3 no.
Primary material	Steel
Type	Ball Butt Bearing
a. Size	
i. Knuckle	Ø 14 mm x 104 mm high
ii. Blades	100 mm high x 35 mm wide x 3 mm thick
b. Fixings	
i. Type	Countersunk wood screws
ii. Material	Stainless Steel
iii. Size	Ø 5 mm x 32 mm long
iv. Number off per blade	5 no.
Position of each hinge relative to the head of the leaf	1 <sup>st</sup> - 170 mm, 2 <sup>nd</sup> – 945 mm, 3 <sup>rd</sup> – 1712 mm
Details of intumescent protection	1mm Interdens (VANQUISH)
Interruptions to Intumescent within the frame reveal	Framefit fireplug sits over the hinges.
<b>29. Door Closer</b>	
Manufacturer	DORMA
Reference	TS92B
a. Material	
i. Body	Mild Steel
ii. Closer arm	Stainless Steel



iii. Cover	Stainless Steel
Configuration	Cam. Action Slide Arm
b. Overall size	
i. Slide arm	524 mm wide x 22 mm thick x 33 mm deep
ii. Body	281 mm high x 65 mm wide x 47 mm deep
iii. Cover	56 mm high x 296 mm wide x 0.5 mm deep
Fixing method	Screwed with 4 no Ø 5 mm x 50 mm stainless steel screws
<b>30. Fireplug Framefit System Details</b>	
Manufacturer	Complete Fire Protection Ltd
Reference	Fireplug FrameFit System for 30-minute fire doors - Ref FF30
Material	Low modulus fire retardant graphite intumescent
a. System Components	
i. Gap spacers (LM Range for 30-minute doors)	Low Modulus (LM) fire retardant intumescent Ref: LM1.5/44, LM3/44, LM5/44
ii. Hinge Side (HE44 for 30-minute doors)	High expansion intumescent Ref: HE44
b. Overall Size	
i. LM/44 Range	44 mm wide x 2100 mm long x 1.5/3/5 mm thick
ii. HE44	44 mm wide x 2100 mm long x 1.5 mm thick
Application Method	Fix required LM profiles to the door frame opposite the door edges by using the double-sided adhesive tape found on the reverse side of each profile. Once the correct number of LM profiles are in place, pin fix through all layers into the door frame using a minimum of 20 mm long panel pins at seal ends. The HE44 is generally used on the hinged side only. It is fitted using the double-sided adhesive tape found on the reverse side of each profile.
c. Door Edge Gap sizes	<b>FrameFit Configuration</b>
i. Hinge (3 mm gap)	1No HE/44
ii. Leading edge (9 mm gap)	1No HE/44 + 1No LM5/44
iii. Top Edge (9 mm gap)	1No HE/44 + 1No LM5/44
<b>31. Fireplug Framefit Bottom</b>	
Manufacturer	Complete Fire Protection Ltd
Reference	Fireplug Framefit - for 30-minute doors
Material	Low modulus fire retardant graphite intumescent

Overall section size	As LM Range
Location (relative to the opening face of the door leaf)	Located on the bottom door edge
Application Method	Fix required LM profiles to the bottom door edge by using the double-sided adhesive tape found on the reverse side of each profile. Once the correct number of LM profiles are in place, encase the profiles with the appropriate BDS cover strip. Then screw/pin fix through all layers into the bottom of the door edge using a minimum of 40 mm long screws/panel pins at approximately 350 mm centres ensuring screws/pins penetrate door edge by minimum of 10 mm.
d. Door Edge Gaps	<b>FrameFit configuration</b>
i. Bottom of leaf (15 - 25 mm gap)	Various LM Range between 15- 25 mm due to the difference in gap at the bottom of the specimen in relation to the restraint frame
<b>32. Lockset / Latch</b>	
Manufacturer	ERA Multi Point Lock
Reference	DLSF 4560985B (SureFire Classic 2)
a. Material	
i. Lockcase	BZP CR3 Passivate + Seal
ii. Forend plate	Stainless Steel 430
iii. Latch bolt	Stainless Steel 304
iv. Lock bolt	Zinc CR3 Passivate + Seal, PTFE insert
v. Top and bottom lock case	BZP CR3 Passivate + Seal
vi. Top and bottom lock hooks	Aluminium anodised 2A50-T6
vii. Keepers	Zinc with Brass roller
b. Overall sizes	
i. Lockcase	213 mm high x 19 mm wide x 55 mm deep
ii. Forend plate	1634 mm high x 20 mm wide x 3 mm thick
iii. Latch bolt	30 mm high x 12 mm wide x 15 mm projection
iv. Lock bolt	30 mm high x 6 mm wide x 20 mm projection
v. Top and bottom lock case	150 mm high x 19 mm wide x 45 mm deep
vi. Center Keeper	170 mm high x 24 mm wide x 3 mm thick with a 50 mm high x 12 mm wide Tongue
vii. Top and bottom Keepers	125 mm high x 24 mm wide x 3 mm thick with a 30 mm high x 12 mm wide Tongue

c. Fixing method	
i. Forend Plate	16 No. Ø 4 x 25 mm CSK woodscrews
ii. Keepers	3 No. Ø 4 x 25 mm CSK woodscrews
Operation of lock bolt	Engaged
d. Details of intumescent protection	
i. Central lock case	1mm Flex Fire (VANQUISH)
ii. Top and bottom lock case	1mm Flex Fire (VANQUISH)
iii. Keepers	1mm Flex Fire (VANQUISH)
Location of centre of the spindle relative to the bottom of the leaf	Centre of the spindle measures 1000 mm from the bottom of the leaf
<b>33. Cylinder with thumbturn</b>	
Manufacturer	ERA
Reference	3* 16010C6D
Material	Brass - Chrome Plated
Overall size	17 mm wide x 33 mm high x 74 mm long
<b>34. Lever handles</b>	
Manufacturer	ERA
Reference	Windsor Sprung Lever Lever
Material	Zinc – Chrome plated.
a. Overall size	
i. Baseplate	206 mm high x 28 mm wide x 8 mm thick
ii. Lever	Ø 17 mm x 130 mm long x 58 mm projection
Fixing method, fixing material, sizes, quantity and location	2no. Ø 5 mm bolt through fixings.
<b>35. Roller Finger Guard</b>	
Manufacturer	Exitex
Reference	Roller Blind Finger Protection
Material	Aluminium casing with fabric between.
Overall size	65 mm wide x 1970 mm high x 2 mm thick
Location	Unexposed stop face of doorset on the hung edge of the door.

Fixing method	12 no 3.5 mm x 25 mm long wood screws @ approx. 150mm centres.
<b>36. Door Pin ID Tag</b>	
Manufacturer	Door Data Systems
Reference	FrameFit DDP
Material	Information chip & plastic
Overall size	Ø 6 mm x 37.5 mm long
Location	Top of hinge side
Fixing method	Friction fitted into door edge.

### 4.3 Specimen C

<b>37. Steel Hatch</b>	
Manufacturer	Complete Fire Protection
Reference	Fire Plug Cable Pass Through System
Model	CPTFRAW190
Material	Mild Steel
a. Overall size	
i. Wall Trim	Ø 355 mm x 50 mm wide x 2 mm thick
ii. Hatch Lid	Ø 350 mm x 2 mm thick
iii. Handle	Ø 35 mm x 30 mm projection
iv. Steel collar	Ø 300 mm x 30 mm wide x 30 mm deep x 2 mm thick
Location	2600 mm up to centre of hatch Ø 305 mm hole
Fixing method	4 No. Ø 4 mm x 50 mm long Screws
<b>38. Intumescent</b>	
Manufacturer	Tenmat
Reference	FF160
Material	Graphite based intumescent
Overall size / location	4 no. layers wrapped around collar – 30 mm wide x 5 mm thick per layer
Fixing method	Friction fitted between steel collar and UPVC Pipe.

39. UPVC Pipe	
Manufacturer	JDP
Reference	Plain Ended Underground Drainage Pipe
Material	PVC-U
Overall size	Ø 260 mm x 132 mm long
Location	Fitted into steel collars of Steel hatches.
40. Smoke Sock	
Manufacturer	Raw fabric bought from Cultima; sock made by Kingswood Canvas Ltd
Reference	Fireplug Cold Smoke Sock
Material	Treated Woven Glass Cloth (Culimeta-Saveguard Ltd Manufactured)
Overall size	Ø 300 mm x 1000 mm long
Location	Fitted around UPVC Pipe.
Rope in Sock Ends	Ø 8 mm Ceramic Fiber Rope (Braided) - Murugappa
41. Acoustic Bung	
Manufacturer	Kingswood Canvas Ltd
Reference	Fireplug Acoustic Bung
Material	128kg Ceramic enclosed in woven glass cloth
Overall size	2No. Ø 300 mm x 50 mm thick
Location	One at each end of passthrough
42. Wires	
Supplier	Toolstation
Reference	Pitcas PVC Cables
Type 1 -	3 No. Ø 6 mm plastic cased wires (yellow)
Type 2 -	1 No. 6 mm wide x 2 mm thick plastic cased wires (grey)

#### 4.4 Specimen D

43. Steel Hatch	
Manufacturer	Complete Fire Protection

Reference	Fire Plug Cable Pass Through System
Model	CPTFRAW150
Material	Mild Steel
b. Overall size	
i. Wall Trim	Ø 305 mm x 50 mm wide x 2 mm thick
ii. Hatch Lid	Ø 300 mm x 2 mm thick
iii. Handle	Ø 35 mm x 30 mm projection
iv. Steel Collar	Ø 203 mm x 30 mm wide x 30 mm deep x 2 mm thick
Location	2600 mm up to centre of hatch Ø 205 mm hole
Fixing method	4 No. Ø 4 mm x 50 mm long Screws
<b>44. Intumescent</b>	
Manufacturer	Tenmat
Reference	FF160
Material	Graphite based intumescent
Overall size / location	4 no. layers wrapped around collar - 5 mm thick per layer
Fixing method	Friction fitted between steel collar and UPVC Pipe.
<b>45. UPVC Pipe</b>	
Manufacturer	JDP
Reference	Plain Ended Underground Drainage Pipe
Material	PVC-U
Overall size	Ø 160 mm x 132 mm long
Location	Fitted into steel collars of Steel hatches.
<b>46. Smoke Sock</b>	
Manufacturer	Raw fabric bought from Cultima; sock made by Kingswood Canvas Ltd
Reference	Fireplug Cold Smoke Sock
Material	Treated Woven Glass Cloth (Culimeta-Saveguard Ltd Manufactured)
Overall size	Ø 160 mm x 1000 mm long
Location	Fitted around UPVC Pipe.
Rope in Sock Ends	Ø 8 mm Ceramic Fiber Rope (Braided) - Murugappa

47. Acoustic Bung	
Manufacturer	Kingswood Canvas Ltd
Reference	Fireplug Acoustic Bung
Material	128kg Ceramic enclosed in woven glass cloth
Overall size	2No. Ø 300 mm x 50 mm thick
Location	One at each end of passthrough
48. Wires	
Supplier	Toolstation
Reference	Pitcas PVC Cables
Type 1 -	3 No. Ø 6 mm plastic cased wires (yellow)
Type 2 -	1 No. 6 mm wide x 2 mm thick plastic cased wires (grey)

## 4.5 Specimen E

49. Steel Hatch	
Manufacturer	Complete Fire Protection
Reference	Fire Plug Cable Pass Through System
Model	CPTFRAW100
Material	Mild Steel
c. Overall size	
i. Wall Trim	Ø 205 mm x 50 mm wide x 2 mm thick
ii. Hatch Lid	Ø 200 mm x 2 mm thick
iii. Handle	Ø 35 mm x 30 mm projection
iv. Steel Collar	Ø 175 mm x 30 mm wide x 30 mm deep x 2 mm thick
Location	2600 mm up to centre of hatch Ø 175 mm hole
Fixing method	4 No. Ø 4 mm x 50 mm long Screws
50. Intumescent	
Manufacturer	Tenmat
Reference	FF160

Material	Graphite based intumescent
Overall size / location	4 no. layers wrapped around collar - 5 mm thick per layer
Fixing method	Friction fitted between steel collar and UPVC Pipe.
<b>51. UPVC Pipe</b>	
Manufacturer	JDP
Reference	Plain Ended Underground Drainage Pipe
Material	PVC-U
Overall size	Ø 175 mm x 132 mm long
Location	Fitted into steel collars of Steel hatches.
<b>52. Smoke Sock</b>	
Manufacturer	Raw fabric bought from Cultima; sock made by Kingswood Canvas Ltd
Reference	Fireplug Cold Smoke Sock
Material	Treated Woven Glass Cloth (Culimeta-Saveguard Ltd Manufactured)
Overall size	Ø 125 mm x 1000 mm long
Location	Fitted around UPVC Pipe.
Rope in Sock Ends	Ø 8 mm Ceramic Fiber Rope (Braided) - Murugappa
<b>53. Acoustic Bung</b>	
Manufacturer	Kingswood Canvas Ltd
Reference	Fireplug Acoustic Bung
Material	128kg Ceramic enclosed in woven glass cloth
Overall size	2No. Ø 125 mm x 50 mm thick
Location	One at each end of passthrough
<b>54. Wires</b>	
Supplier	Toolstation
Reference	Pitcas PVC Cables
Type 1 -	3 No. Ø 6 mm plastic cased wires (yellow)
Type 2 -	1 No. 6 mm wide x 2 mm thick plastic cased wires (grey)



## 4.6 Supporting Construction

55. Metal Frame	
Supplier	UKTC Provided
d. Supporting Structure	
i. Type & Material	Steel C Stud
ii. Thickness & Size	72 mm wide x 34 mm thick x 3000 mm long
iii. Centres	600 mm Centres 20 mm Space between testing frame and wall frame for insulation.
Additional Wall Construction Requests	N/a
56. Plasterboard	
Supplier	UKTC Provided
Type & Material	Gypsum Plasterboard Tapered Edge
Layer Quantity	2
Thickness & Size	12.5 mm per layer 25 mm total x 2400 mm x 1200 mm Per Sheet
Fixings	Plasterboard Screw Fixings Ø 5 mm x 25 mm Long Screw
Joints Filled & Taped With	Limestone filler & Butyl rubber
57. Wall Insulation	
Supplier	UKTC Provided
Type & Material	Mineral Wool
Installation Method	Compression Fitted
Thickness	50 mm
Locations	Centrally Located in the wall & at the free edges of the testing frame to the wall.
Additional Wall Construction Requests	N/a

## 5 Specimen Photographs



Figure 8 - Item 1



Figure 9 - Item 14

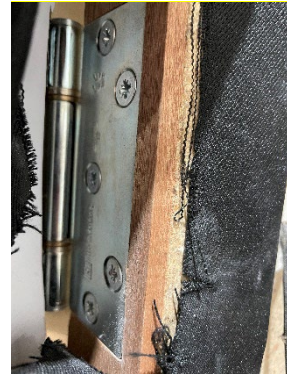

Figure 10 - Item 28



Figure 11 - Item 32



Figure 12 - Item 33



Figure 13 - Item 16 & 34



Figure 14 - Item 18

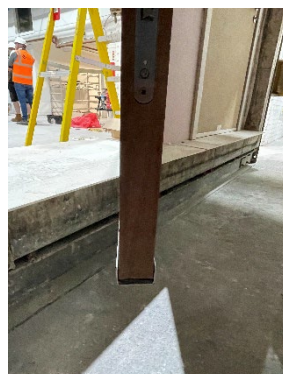

Figure 15 - Item 12, 13, 30 & 31



Figure 16 - Item 19 & 36

## 6 Test Procedure

### 6.1 Heating Conditions

The specimens were subject to heating conditions in accordance with BS EN 1363-1:2020 § 5.1. This was monitored and controlled for the duration of the test using type K thermocouples which were distributed across a vertical plane  $100 \pm 50$  mm from the exposed surface of the test construction. The resulting Time-Temperature distribution is presented in Figure 34.

### 6.2 Pressure Conditions

The specimens were subject to a pressure regime in accordance with BS EN 1363-1:2020 § 5.2. The calculated pressure differential relative to the laboratory atmospheric pressure at a height of 365, 1612 and 2850 mm from the furnace floor level was -1.1, 9.4 and 20.0 Pa respectively which equates to 0 Pa at a height of 500 mm from the furnace floor level. The furnace was maintained at these pressures within  $\pm 5$  Pa five minutes after the commencement of the test and  $\pm 3$  Pa ten minutes after the commencement of the test and for the remainder of the test duration. The pressure deviated from the specified conditions on 1 instance throughout the duration of the test. The Time-Pressure distribution is presented in Figure 35.

### 6.3 Unexposed Surface Temperature

A roving thermocouple was available for the evaluation of the maximum temperature rise of the unexposed surface of the specimens for the duration of the test. Any measurements using the roving thermocouple are presented on page 45.

#### 6.3.1 Doorsets

Disc thermocouples were affixed to the unexposed surface of the specimens in accordance with BS EN 1634-1:2014+A1:2018 § 9.1.2 to measure and monitor the maximum and the mean temperature rise of the unexposed surface of the specimens for the duration of the test. A summary of the measurements is presented in Figure 36 and Figure 37 and the locations of these thermocouples is illustrated in Figure 7.

#### 6.3.2 Cable passthroughs

Disc thermocouples were affixed to the unexposed surface of the specimens in accordance where applicable with BS EN 1366-3:2021 § 9.1.2 to measure and monitor the maximum temperature rise of the unexposed surface of the specimens for the duration of the test. The locations of these thermocouples are illustrated in Figure 7.

### 6.4 Deflection

All measurements are in millimeters (mm) unless stated otherwise. Positive values indicate movement towards the heating conditions.

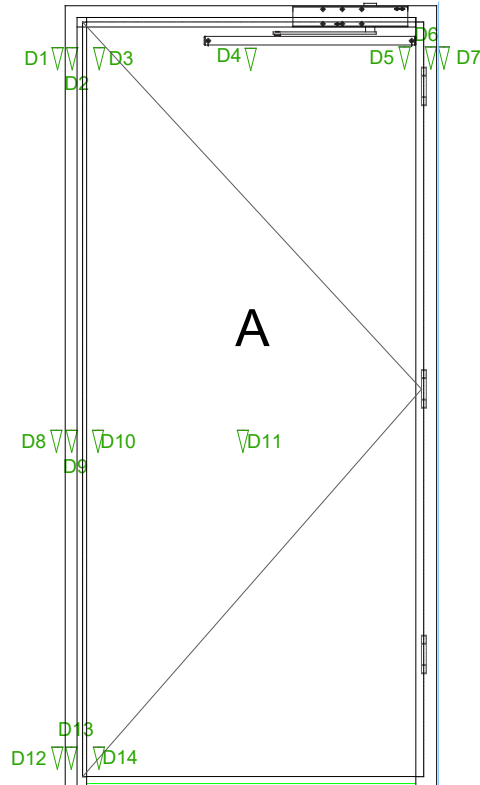

Time (mins)	D1	D2	D3	D4	D5	D6	D7	D8	D9	D10	D11	D12	D13	D14
0	0	0	0	0	0	0	0	0	0	0	0	0	0	0
10	1	3	2	4	6	4	6	4	4	4	8	0	1	4
20	2	2	10	5	9	6	6	6	6	8	8	0	2	14
25	1	2	8	3	6	4	5	6	7	0	7	0	1	14
30	2	3	8	4	5	3	5	6	6	7	5	0	1	15
35	2	1	7	2	4	3	6	5	7	-5	1	0	1	16

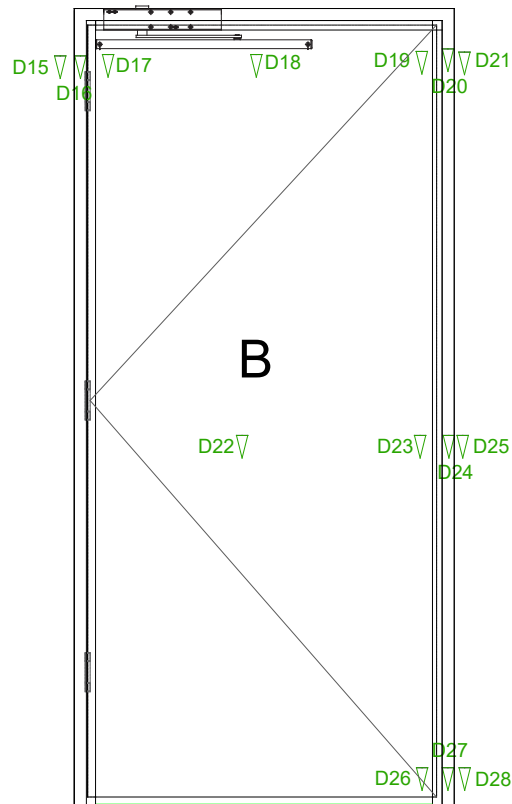

Time (mins)	D15	D16	D17	D18	D19	D20	D21	D22	D23	D24	D25	D26	D27	D28
0	0	0	0	0	0	0	0	0	0	0	0	0	0	0
10	6	6	6	6	1	3	0	2	5	2	1	0	7	1
20	5	8	6	5	2	3	3	0	2	3	2	-1	-2	1
25	3	6	3	3	2	3	-2	-2	0	1	1	2	7	3
30	2	6	4	2	0	6	0	-7	0	3	3	3	5	1
35	2	8	3	2	5	5	0	-11	2	0	-1	2	-1	1
40	2	5	4	5	6	2	-1	-16	-4	1	1	3	2	1
45	2	5	3	1	5	5	-2	-18	3	2	0	2	1	-2
50	4	4	0	2	3	1	1	-30	0	2	0	5	4	-2

## 6.5 Observations

Specimen	HH	MM	SS	E <sup>13</sup>	U <sup>14</sup>	Observation
	00	00	00			<b>The test commences.</b>
A	00	00	55		X	Smoke/steam release top of door.
A	00	01	16		X	Smoke/steam release latch side.
B	00	01	35		X	Smoke/steam release top of door.
C/D	00	01	53		X	Smoke/steam release around sock.
B	00	02	56		X	Smoke/steam release latch side.
D	00	03	16		X	Smoke/steam release around sock.
A	00	03	51		X	Discolour down latch side.
C/D/E	00	05	10		X	Discolour of socks.
B	00	08	01		X	Smoke/steam release along bottom edge.
A	00	08	28		X	Top of door deflecting towards heat.
C	00	10	25		X	Smoke/steam release continuing to increase.
B	00	11	22		X	Smoke/steam hinge side coming out at bottom of hinge protector.
A	00	12	33		X	Smoke/steam release from handle.
C	00	12	46	X		Door fallen away and hanging near door closer.
C	00	16	07		X	Moisture releasing from specimen.
B	00	16	54		X	Top of door is deflecting towards heat.
A	00	17	38		X	Bottom of door is deflecting towards heat.

<sup>13</sup> Viewed from exposed surface of the test construction.

<sup>14</sup> Viewed from unexposed surface of the test construction.

C/D	00	20	27		X	Discolour of wall around doors.
B	00	22	26		X	Smoke/steam release at lock.
B	00	22	30		X	Discolour around handle.
A	00	23	21		X	Discolour top corner hinge side.
C	00	29	15		X	Temp 180°C.
<b>A</b>	<b>00</b>	<b>38</b>	<b>00</b>			<b>Observations on the specimen discontinued and has been hosed down and blanked off so that evaluation may continue specimen B, C, D and E.</b>
B	00	45	22		X	Discolour around door handle is increasing and handle has dropped.
B	00	53	19		X	Discolour top corner hinge side.
<b>B</b>	<b>00</b>	<b>55</b>	<b>00</b>		<b>X</b>	<b>Door sprayed as met all criteria and blanked off to continue test on specimen 'C'.</b>
C	00	59	10		X	Cotton pad applied at top no embers or discolouration.
E	01	07	08		X	Discolouration on right hand side.
C	01	11	10		X	Glowing at left side.
C	01	11	10		X	Cotton pad applied no discolour.
C	01	22	00		X	Cotton pad applied no discolour.
<b>C</b>	<b>01</b>	<b>26</b>	<b>30</b>		<b>X</b>	<b>Cotton pad applied glowing embers. Cotton Wool pad integrity failure is deemed to have occurred.</b>
<b>C</b>	<b>01</b>	<b>31</b>	<b>24</b>		<b>X</b>	<b>Penetration flap fell away, now blanked off entire specimen. The sustained flame and gap gauge criteria can no longer be evaluated.</b>
<b>D</b>	01	37	47		X	Sock is very black and frame is becoming discoloured.
C/D	01	49	22	X		Both doors have fallen away.
	<b>02</b>	<b>15</b>	<b>34</b>		<b>X</b>	<b>The test is discontinued at the request of the Test Sponsor.</b>

## 6.6 Test Images



Figure 17 – The exposed surface of the test construction prior to commencement of the test



Figure 18 - The unexposed surface of the test construction prior to the commencement of the test





Figure 19 - The unexposed surface of the test construction after a test duration of 10 minutes



Figure 20 - The unexposed surface of the test construction after a test duration of 20 minutes



Figure 21 - The unexposed surface of the test construction after a test duration of 30 minutes



Figure 22 - The unexposed surface of the test construction after a test duration of 35 minutes



Figure 23 - The unexposed surface of the test construction after a test duration of 55 minutes



Figure 24 - The unexposed surface of the test construction after a test duration of 62 minutes



Figure 25 - The unexposed surface of the test construction after a test duration of 80 minutes



Figure 26 - The unexposed surface of the test construction after a test duration of 92 minutes



Figure 27 - The unexposed surface of the test construction after a test duration of 95 minutes



Figure 28 - The unexposed surface of the test construction after a test duration of 100 minutes



Figure 29 - The unexposed surface of the test construction after a test duration of 110 minutes



Figure 30 - The unexposed surface of the test construction after a test duration of 120 minutes



Figure 31 - The unexposed surface of the test construction after a test duration of 132 minutes



Figure 32 - The unexposed surface of the test construction after a test duration of 136 minutes



Figure 33 - The exposed surface of the test construction after the test was discontinued



## 7 On-going Implications

### 7.1 Limitations

This report details the method of construction, the test conditions and the results obtained when the specific element of construction described herein was tested following the procedure outlined in BS EN 1363-1, and where appropriate BS EN 1363-2. Any significant deviation with respect to size, constructional details, loads, stresses, edge or end conditions other than those allowed under the field of direct application in the relevant test method is not covered by this report and should be the subject to design appraisal by a competent individual.

Guidance on the field of direct application of results is presented in Appendix A.

### 7.2 Accuracy of Results

Due to the nature of fire resistance testing and the consequent difficulty in quantifying the uncertainty of measurement of fire resistance, it is not possible to provide a stated degree of accuracy of the result.

No statement of conformity with the testing specifications is made or implied in this report. However, measurement results are reviewed, where applicable, to establish where measurement results exceed the control parameters established in the relevant resistance to fire test standard.

### 7.3 European Group of Organisations for Fire Testing (EGOLF)

Certain aspects of some fire test specifications are open to different interpretations. EGOLF have identified several such areas and have agreed Resolutions which define common agreement of interpretations between fire test laboratories which are members of the Group. Where such Resolutions are applicable to this test then they have been followed.

## Figures

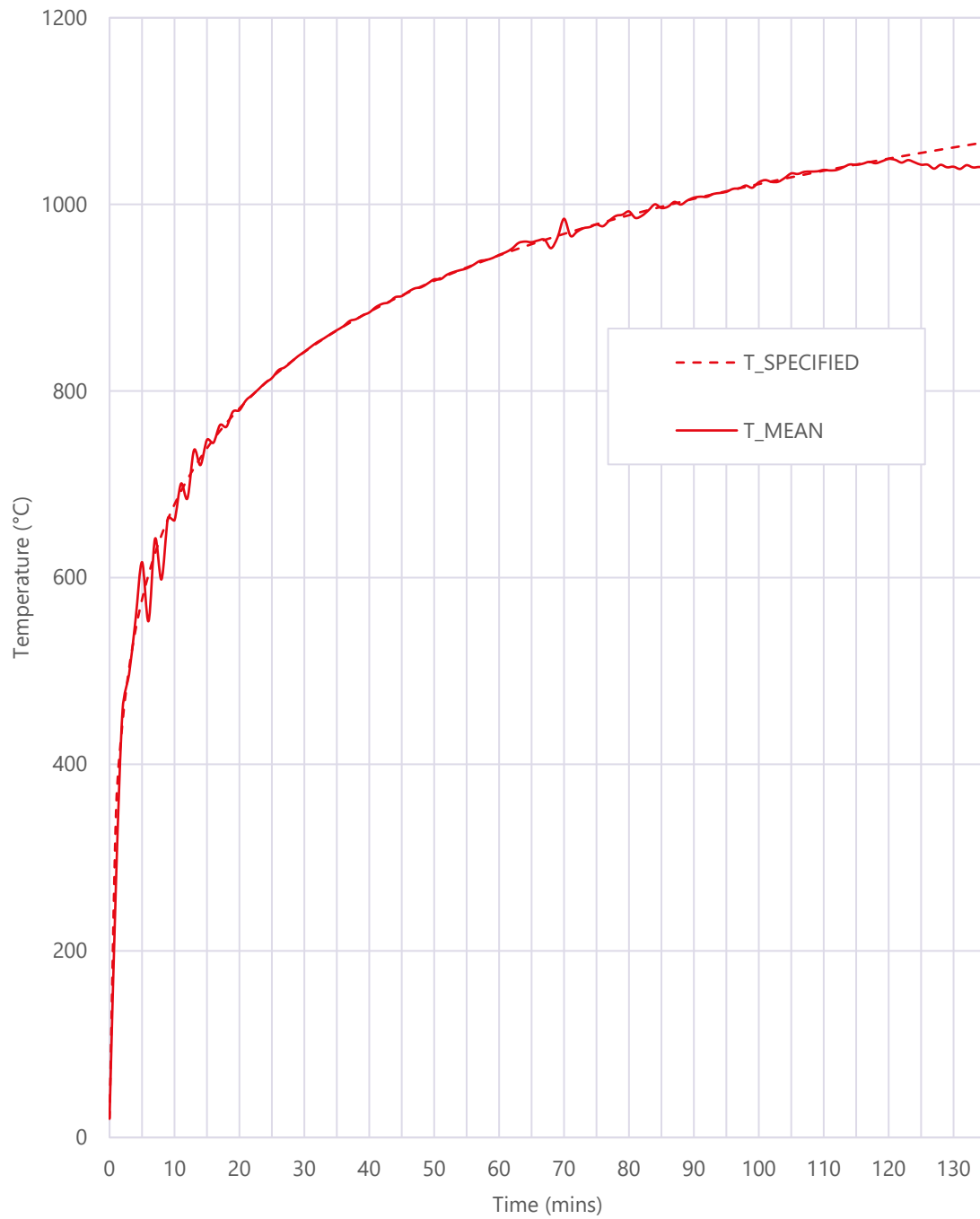

Figure 34 – Graph presenting the Time-Temperature distribution of the furnace

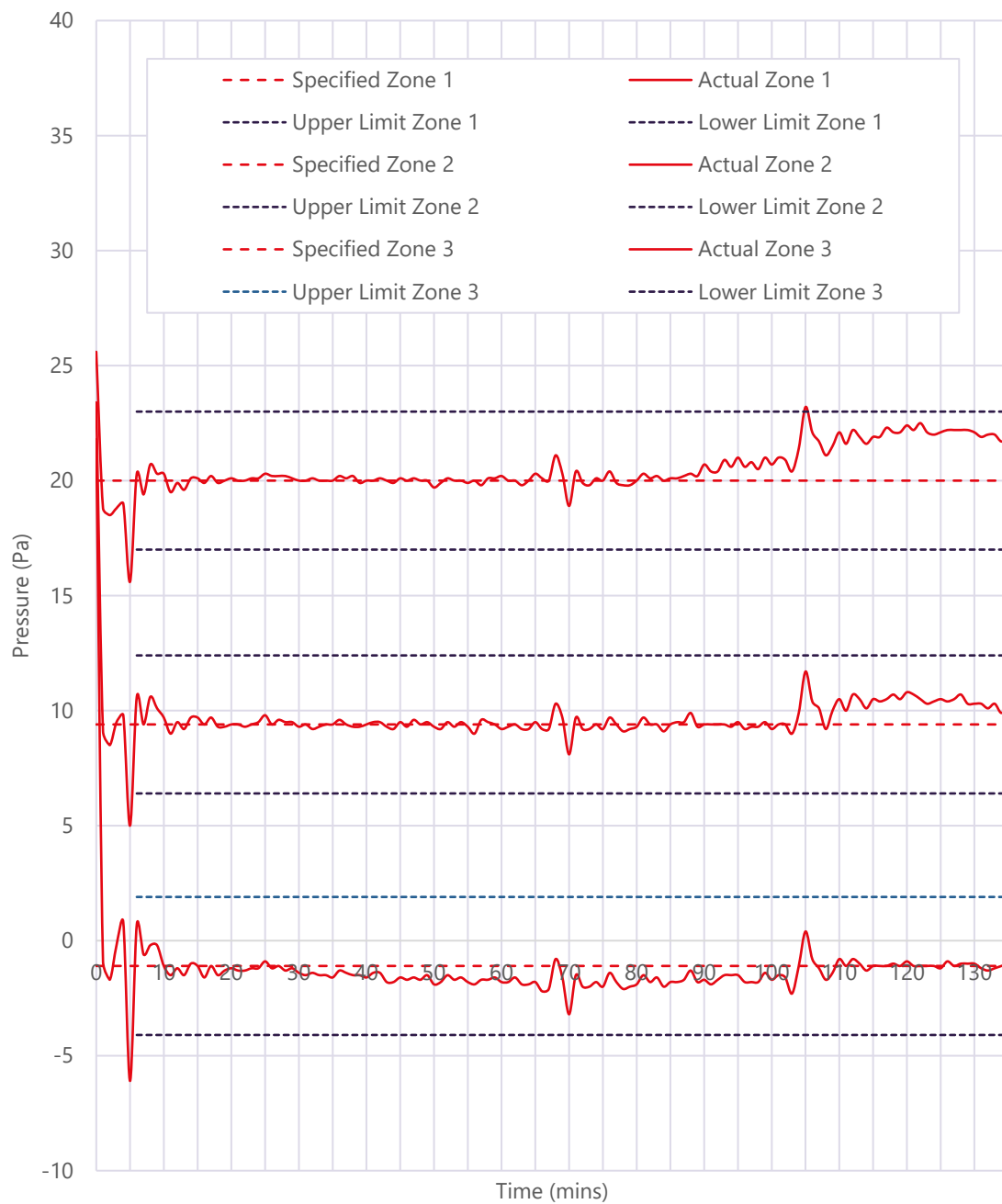

Figure 35 – Graph presenting the Time-Pressure distribution of the furnace

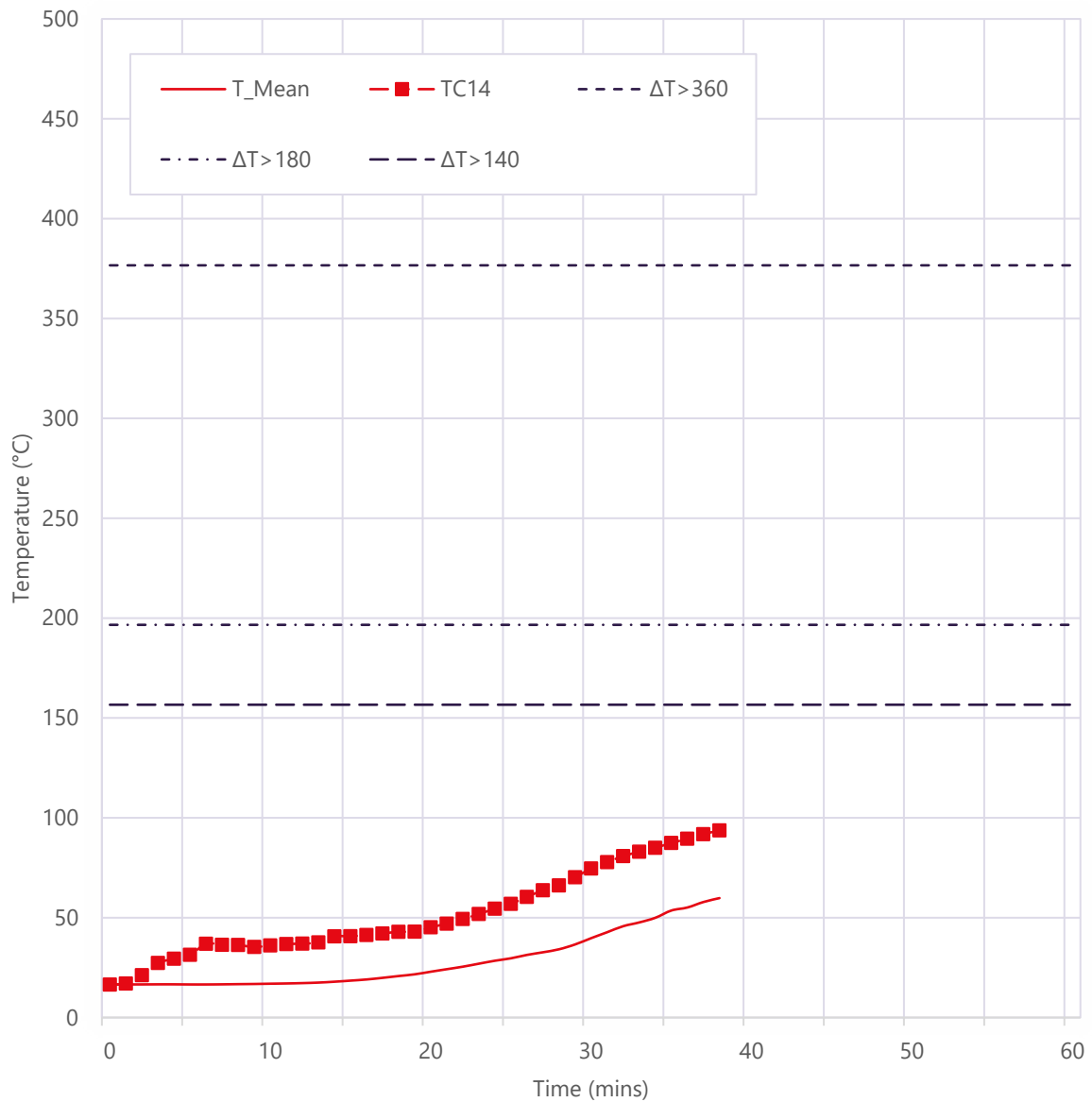

Figure 36 - Graph presenting the Time-Temperature distribution of the unexposed surface of Specimen A

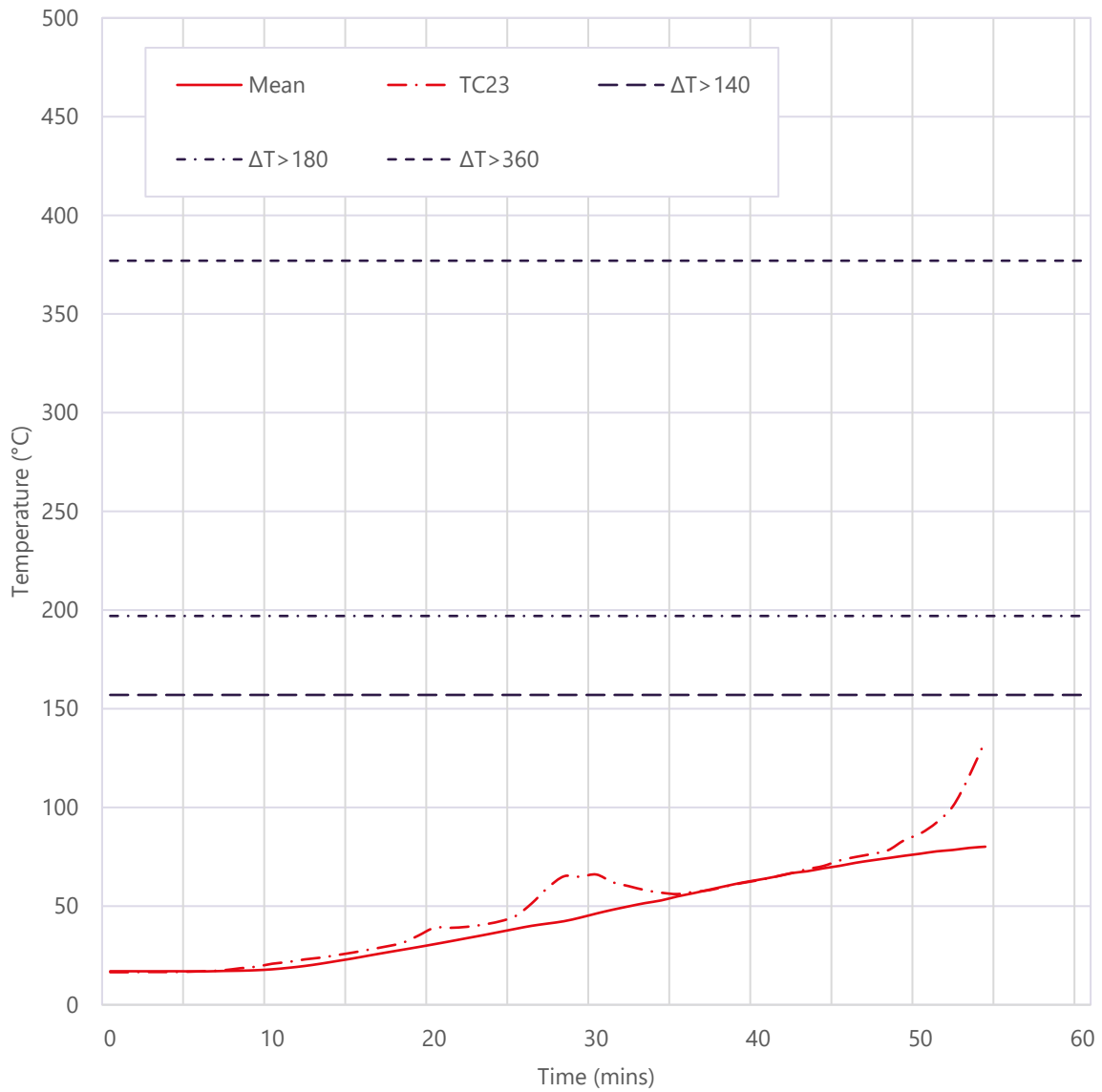

Figure 37 - Graph presenting the Time-Temperature distribution of the unexposed surface of Specimen B

## Tables

Table 1 – The temperatures recorded by the disc thermocouples used evaluate the mean and maximum temperature rise of the unexposed surface of Specimen A under the normal procedure (I<sub>2</sub>). Values are in Degrees Celsius (°C) unless otherwise stated.

Time (mins)	TC1	TC2	TC3	TC4	TC5
0	16.7	17.0	16.5	16.6	16.3
2	16.6	16.9	16.5	16.6	16.3
4	16.7	16.9	16.6	16.6	16.3
6	16.7	16.8	16.5	16.5	16.3
8	16.8	17.0	16.6	16.7	16.5
10	16.9	17.3	16.9	16.9	16.7
12	17.1	17.8	17.2	17.1	17.0
14	17.9	18.6	17.9	17.6	17.7
16	18.9	20.1	19.0	18.5	18.8
18	20.3	22.7	20.7	19.7	20.5
20	21.9	26.2	22.8	21.1	22.7
22	24.1	29.8	25.4	22.8	25.2
24	26.9	33.7	28.5	25.0	28.1
26	30.0	36.4	31.6	27.4	31.4
28	33.3	38.8	34.3	29.4	35.1
30	41.4	41.8	38.2	33.2	44.1
32	50.1	45.1	42.3	38.9	52.3
34	55.0	47.9	44.6	43.4	58.8
36	59.7	51.9	48.5	50.9	64.5
38	62.6	57.3	52.6	58.4	68.1

Table 2 – The temperatures recorded by the disc thermocouples used to evaluate the maximum temperature rise of the door leaf of Specimen A under the normal procedure (I<sub>2</sub>). Values are in Degrees Celsius (°C) unless otherwise stated.

Time (mins)	TC10	TC11	TC12	TC13
0	16.9	17.2	16.9	16.7
2	17.7	17.7	17.0	16.6
4	19.0	17.3	16.9	16.7
6	18.8	17.2	16.9	16.6
8	18.1	17.4	17.1	16.8
10	18.0	17.6	17.3	17.0
12	19.0	17.9	17.6	17.4
14	20.1	18.6	18.4	18.3
16	21.7	19.6	19.7	19.6
18	23.3	21.3	21.6	21.5
20	25.6	23.7	24.4	24.4
22	28.6	26.7	27.8	28.0
24	31.9	30.0	31.6	31.5
26	35.4	33.6	35.3	34.9
28	38.4	36.9	38.4	37.9
30	41.7	41.2	42.1	41.6
32	45.8	46.8	46.3	45.2
34	47.8	51.5	49.7	48.2
36	51.9	56.9	54.1	52.9
38	56.5	63.5	59.5	59.4

Table 3 – The temperatures recorded by the disc thermocouples used evaluate the maximum temperature rise of the door leaf of Specimen A under the supplementary procedure (I<sub>1</sub>). Values are in Degrees Celsius (°C) unless otherwise stated.

Time (mins)	TC14	TC15	TC16	TC17
0	16.5	17.7	16.3	17.4
2	21.2	27.4	16.4	17.5
4	29.4	21.7	16.5	17.4
6	36.9	20.2	16.5	17.4
8	36.3	20.5	17.1	17.5
10	36.1	21.2	19.5	17.8
12	37.0	21.4	21.5	18.3
14	40.6	22.6	23.8	19.3
16	41.3	25.2	27.2	20.9
18	42.9	29.3	31.1	23.1
20	45.2	32.9	35.7	25.9
22	49.3	36.8	37.6	29.2
24	54.5	41.1	41.4	33.2
26	60.4	45.2	45.7	38.3
28	66.1	48.3	50.5	43.1
30	74.6	51.6	57.8	48.3
32	80.8	55.3	63.4	53.9
34	85.0	57.8	66.9	71.7
36	89.5	62.7	72.2	70.7
38	93.7	69.8	79.9	72.4



Table 4 – The temperatures recorded by the disc thermocouples used to evaluate the maximum temperature rise of the frame/ transom members adjacent to the door leaf of Specimen A. Values are in Degrees Celsius (°C) unless otherwise stated.

Time (mins)	TC6	TC7	TC8	TC9
0	16.3	16.2	16.4	16.8
2	16.6	17.0	16.8	16.7
4	17.3	16.6	17.1	16.8
6	17.3	16.7	16.7	16.7
8	17.3	17.1	16.7	16.9
10	17.4	17.5	17.1	17.0
12	17.8	17.7	17.7	17.0
14	18.0	18.8	18.6	17.3
16	18.2	20.6	19.5	17.7
18	18.8	22.2	21.1	18.5
20	19.7	23.8	23.4	19.8
22	20.7	26.4	26.0	21.5
24	22.0	28.2	26.8	23.2
26	23.6	30.6	28.3	25.1
28	25.1	33.9	29.7	26.9
30	26.7	36.0	30.4	29.4
32	28.5	36.7	33.2	32.0
34	29.9	37.8	34.8	34.4
36	31.8	39.1	37.2	37.4
38	33.6	40.6	40.9	40.0

Table 5 – The temperatures recorded by the disc thermocouples used evaluate the mean and maximum temperature rise of the unexposed surface of Specimen B under the normal procedure (I<sub>2</sub>). Values are in Degrees Celsius (°C) unless otherwise stated.

Time (mins)	TC18	TC19	TC20	TC21	TC22
0	17.3	17.3	17.0	16.8	16.6
3	17.3	17.3	17.0	16.7	16.6
6	17.2	17.2	17.0	16.7	16.6
9	17.8	17.9	17.6	17.2	17.1
12	19.6	20.8	19.5	18.9	19.5
15	22.7	25.8	22.9	21.9	24.3
18	26.4	30.9	27.0	25.5	29.4
21	30.6	35.4	31.2	29.7	34.1
24	35.5	39.9	35.9	34.4	38.6
27	40.4	44.1	40.2	38.8	42.3
30	46.1	48.6	45.4	44.3	46.8
33	51.7	53.1	50.8	50.3	51.7
36	57.4	57.4	56.3	55.2	56.5
39	62.8	62.0	61.8	61.5	61.4
42	68.0	66.1	66.6	67.2	65.4
45	71.5	69.2	70.7	71.1	69.4
48	75.4	72.2	73.6	77.3	73.1
51	78.8	75.1	76.9	81.5	76.4
54	80.7	77.5	79.4	83.4	79.5
55	40.3	43.3	64.5	27.0	50.7

Table 6 – The temperatures recorded by the disc thermocouples used to evaluate the maximum temperature rise of the door leaf of Specimen B under the normal procedure (I<sub>2</sub>). Values are in Degrees Celsius (°C) unless otherwise stated.

Time (mins)	TC27	TC28	TC29	TC30
0	16.9	17.0	17.3	16.6
3	16.8	17.0	17.4	16.6
6	16.8	17.0	17.3	16.7
9	17.4	17.3	17.8	18.9
12	19.2	18.9	20.4	25.3
15	22.5	21.4	25.1	32.9
18	26.5	24.4	29.6	40.8
21	31.1	27.7	34.1	47.2
24	36.3	31.7	38.0	53.0
27	41.2	36.5	42.4	57.2
30	46.8	42.5	47.2	60.9
33	53.2	49.6	51.4	64.3
36	58.9	56.6	56.3	67.1
39	65.4	64.4	59.7	70.2
42	70.7	71.3	63.6	72.5
45	74.0	77.0	69.2	75.0
48	78.2	81.7	71.6	77.2
51	81.7	84.8	74.7	80.0
54	83.8	87.1	78.5	82.6
55	23.6	54.4	52.5	52.9

Table 7 – The temperatures recorded by the disc thermocouples used evaluate the maximum temperature rise of the door leaf of Specimen B under the supplementary procedure (I<sub>1</sub>). Values are in Degrees Celsius (°C) unless otherwise stated.

Time (mins)	TC31	TC32	TC33	TC34
0	16.8	16.5	18.1	17.2
3	16.8	16.6	21.8	17.3
6	16.8	16.5	21.5	17.6
9	17.5	16.8	21.8	24.6
12	19.6	17.7	26.3	36.3
15	23.2	20.3	32.8	44.7
18	28.4	24.9	38.6	49.5
21	34.3	30.8	44.8	54.5
24	40.7	37.1	48.5	59.2
27	46.2	42.7	53.6	63.5
30	51.9	47.9	59.1	68.9
33	58.1	53.8	64.1	72.5
36	64.2	59.4	68.0	75.2
39	70.0	65.7	71.4	77.4
42	74.8	71.1	74.6	80.6
45	78.8	74.8	78.3	82.9
48	81.6	79.4	80.1	86.1
51	83.9	82.9	82.3	*
54	86.4	87.4	84.7	*
55	37.1	81.0	68.1	*

\*Instrument malfunction

Table 8 – The temperatures recorded by the disc thermocouples used to evaluate the maximum temperature rise of the frame/ transom members adjacent to the door leaf of Specimen B. Values are in Degrees Celsius (°C) unless otherwise stated.

Time (mins)	TC23	TC24	TC25	TC26
0	16.5	16.2	17.4	16.7
3	16.6	16.2	20.6	16.7
6	17.1	16.1	19.2	16.7
9	19.3	16.3	18.7	18.3
12	23.0	16.5	19.4	18.6
15	26.5	17.3	21.2	18.6
18	31.3	18.5	23.3	19.2
21	39.0	21.1	25.6	19.3
24	42.2	23.8	27.3	20.0
27	59.3	27.5	28.6	21.0
30	66.0	30.1	30.7	22.1
33	58.1	32.1	33.6	23.9
36	57.2	34.9	34.0	26.2
39	61.7	35.9	35.3	27.9
42	66.6	37.6	36.3	29.8
45	73.1	39.8	37.9	32.4
48	78.3	40.6	39.4	33.5
51	92.4	43.5	41.4	35.0
54	134.0	49.4	43.3	37.2
55	26.6	51.3	41.9	34.3

Table 10 – The temperatures recorded by the disc thermocouples used evaluate the maximum temperature rise of the unexposed surface of Specimen C under the normal procedure (I<sub>2</sub>). Values are in Degrees Celsius (°C) unless otherwise stated.

Time (mins)	TC35	TC36	TC37	TC38	TC39
0	17.1	16.4	18.5	16.5	16.5
6	25.6	43.5	72.6	18.9	16.7
12	34.7	68.3	110.8	23.5	17.9
18	43.8	89.3	93.2	24.9	19.2
24	59.0	123.3	93.0	25.4	20.3
29	60.5	195.7	92.9	25.8	21.4
30	62.7	<b>202.6</b>	88.8	25.9	21.6
36	65.6	225.3	86.9	26.3	23.2
42	65.7	229.4	94.0	28.4	25.0
48	66.9	239.6	85.0	26.9	20.9
54	74.0	260.3	82.3	25.6	17.9
59	160.8	463.7	83.1	*	18.4
60	<b>230.4</b>	475.1	83.7	*	19.3
66	277.2	447.4	91.9	*	18.9
72	315.1	472.3	100.3	*	20.4
78	364.8	501.4	101.8	*	21.6
84	386.8	509.8	110.0	*	22.5
90	429.3	519.8	120.8	*	24.1
96	*	*	*	*	*
102	*	*	*	*	*
108	*	*	*	*	*
114	*	*	*	*	*
120	*	*	*	*	*
126	*	*	*	*	*
132	*	*	*	*	*
135	*	*	*	*	*

\*Specimen blanked off

Table 11 – The temperatures recorded by the disc thermocouples used evaluate the maximum temperature rise of the unexposed surface of Specimen D under the normal procedure (I<sub>2</sub>). Values are in Degrees Celsius (°C) unless otherwise stated.

Time (mins)	TC40	TC41	TC42	TC43	TC44
0	16.6	16.9	17.9	17.1	17.2
6	19.9	36.9	46.9	21.0	26.1
12	30.9	82.6	51.4	20.5	23.5
18	44.9	89.9	45.8	20.2	28.2
24	49.5	87.1	44.2	20.9	41.4
30	53.8	87.1	49.8	22.6	49.6
36	55.3	86.5	48.3	23.9	52.6
42	55.1	86.2	49.5	24.8	53.6
48	55.6	85.5	48.8	25.8	56.1
54	56.7	84.2	52.0	25.9	57.6
60	54.5	85.9	19.7	26.4	59.4
66	52.6	86.2	18.6	25.0	57.7
72	51.6	90.4	20.0	25.7	56.5
78	50.2	92.7	21.0	26.3	56.1
84	52.1	95.0	21.4	27.9	57.8
90	55.6	100.6	21.2	29.0	59.5
96	54.7	109.1	23.4	29.6	62.0
102	58.8	122.5	23.1	29.5	62.4
108	58.0	128.8	*	27.8	63.1
114	58.8	136.8	*	29.7	74.4
120	65.0	160.2	*	32.4	75.7
124	70.3	186.9	*	34.6	80.3
125	68.9	<b>195.3</b>	*	35.4	80.9
126	68.4	203.0	*	35.8	81.5
132	75.6	246.4	*	38.6	84.7
135	79.3	263.6	*	40.7	86.1

\*Instrument malfunction

Table 12 – The temperatures recorded by the disc thermocouples used evaluate the maximum temperature rise of the unexposed surface of Specimen E under the normal procedure (I<sub>2</sub>). Values are in Degrees Celsius (°C) unless otherwise stated.

Time (mins)	TC45	TC46	TC47	TC48	TC49
0	17.2	15.9	16.8	16.5	16.9
6	21.2	45.7	27.3	20.0	25.2
12	27.0	78.0	17.8	19.1	22.2
18	33.7	88.3	18.9	18.5	21.7
24	44.1	92.2	19.9	18.6	29.1
30	52.9	91.5	23.1	19.3	45.6
36	56.1	90.3	26.5	21.0	51.4
42	58.0	89.4	28.1	21.0	55.1
48	57.8	89.3	31.0	22.1	56.0
54	57.0	89.7	32.8	23.0	55.8
60	58.0	90.0	34.1	25.4	58.8
66	57.8	90.3	35.5	25.8	60.5
72	57.3	90.8	51.9	24.3	76.6
78	56.1	91.8	31.5	20.2	65.7
84	55.0	93.4	31.4	20.8	63.6
90	53.7	95.6	33.4	22.4	63.4
96	52.8	99.4	34.6	24.2	65.4
102	53.1	102.3	38.5	26.3	66.3
108	54.1	106.3	36.5	26.8	68.5
114	54.7	109.7	40.3	29.8	68.8
120	56.8	114.1	38.2	29.7	70.7
126	57.2	118.0	37.8	29.7	68.4
132	58.5	122.0	39.9	32.3	70.7
133	72.1	184.8	51.0	45.8	79.8
134	73.7	<b>194.2</b>	52.8	46.9	80.9
135	74.6	205.4	53.3	47.6	81.4



## Appendix A In accordance with BS EN 1634-1:2014 +A1:2018

### A.1 General

The field of direct application defines the allowable changes to the test specimen following a successful fire resistance test. These variations can be applied automatically without the need for the sponsor to seek additional evaluation, calculation or approval.

### A.2 Materials And Construction

#### A.2.1 General

Unless otherwise stated in the following text, the materials and construction of the doorset or openable window shall be the same as that tested. The number of leaves and the mode of operation (e.g. sliding, single action or double action) shall not be changed.

#### A.2.2 Decorative Finishes

##### A.2.2.1 Paint

Where the paint finish is not expected to contribute to the fire resistance of the door, alternative paints are acceptable and may be added to door leaves or frames for which unfinished test specimens were tested. Where the paint finish contributes to the fire resistance of the door (e.g. intumescent paints) then no change shall be permitted.

##### A.2.2.2 Decorative Laminates

Decorative laminates and timber veneers up to 1,5 mm thickness may be added to the faces (but not the edges) of doors that satisfy the insulation criteria (normal or supplementary procedure).

Decorative laminates and timber veneers applied to door leaves that do not satisfy the insulation criteria (normal or supplementary procedure) and/or those in excess of 1,5 mm thickness shall be tested as part of the test specimen. For all doorsets tested with decorative laminate faces, the only variations possible shall be within similar types and thicknesses of material (e.g. for colour, pattern, supplier).

#### A.2.3 Fixings

The number of fixings per unit length used to attach doorsets to supporting constructions may be increased, but shall not be decreased and the distance between fixings may be reduced but shall not be increased.

#### A.2.4 Building Hardware

The number of hinges and dog bolts may be increased but shall not be decreased.

NOTE 1 The number of movement restrictors such as locks and latches is not covered by direct application.

Where a doorset has been tested with a door closing device fitted, but with the retention force released in accordance with 10.1.4, the doorset may be provided either with or without that closing device, i.e. where self-closing characteristics are not required.

NOTE 2 Interchange of building hardware is not covered by the field of direct application.

## A.3 Permissible Size Variations

### A.3.1 General

Doorsets of sizes different from those of tested specimens are permitted within certain limitations, but the variations are dependent on product type and the length of time that the performance criteria are fulfilled.

The increase and decrease of dimensions permitted by the field of direct application are applicable to the overall size and to each door leaf, each side panel and each over panel independently.

In accordance with 13.2.2.3, the dimensions (width and height) of any glass pane cannot be increased.

### A.3.2 Test Periods

The amount of variation of size permitted is dependent on whether the classification time was just reached (Category 'A') or whether an extended time (Category 'B') in accordance with the values shown in Table 9 were fulfilled before the test was concluded.

Table 9 - Category B overrun requirements

Classification time (min)	Performance criteria fulfilled for at least (min)
15	18
20	24
30	36
45	52
60	68
90	100
120	132
180	196
240	260

### A.3.3 Size variation related to product type

#### A.3.3.1 General

The rules to cover increase or decrease of size without additional considerations are applicable only to six main product groups:

- a) hinged and pivoted doorsets and openable windows;
- b) horizontally sliding and vertically sliding doorsets including sectional doorsets;
- c) steel single skin folding shutters doorsets (uninsulated);
- d) other sliding and folding doorsets (insulated);
- e) rolling shutter doorsets;
- f) openable fabric curtains.

No increases in size are permitted for doorsets which are required to satisfy radiation control levels unless the insulation criteria are also satisfied. This is because any increase in size will increase the radiation received at a fixed distance away from the door. There are calculation methods which can be used to determine acceptable size increases for such doors; however, these are beyond the scope of direct application. Doors that satisfy both the radiation control levels and insulation criteria may have their sizes increased as outlined in Annex B. This is accepted because the increase in radiation resulting from a size increase allowed under this section, for an insulated door, will be such that it will still satisfy the required radiation control levels. Size decreases are permitted for both doors which satisfy radiation control levels and those which satisfy insulation criteria and radiation control levels.

Permissible variations for each product group are detailed in Annex B which also contains some examples relating to hinged/pivoted doorsets.

Size increases for doorsets which do not fall into one of the six groups given above are the subject of extended application.

#### **A.3.3.2 Hinged and pivoted doorsets and openable windows**

For Category 'A' tests with no overrun of classification period, no increase is allowed. Unlimited reductions from the tested specimen are permitted with the exception of insulated metal doors where the size reduction is limited.

For Category 'B' tests (with specified overrun of classification period) all smaller sizes are permitted and increases in height and width are permitted as stated in Annex B.

#### **A.3.3.3 Other Changes**

For smaller doorset sizes the relative positioning of movement restrictors (e.g. hinges and latches) shall remain the same as tested or any change to the distances between them will be limited to the same percentage reduction as the decrease of test specimen size.

For larger doorset sizes the following shall also apply:

- a) the height of the latch above floor level shall be equal to or greater than the tested height, and such increase in height shall be at least proportional to the increase in door height;
- b) the distance of the top hinge from the top of door leaf shall be equal to or less than that tested;
- c) the distance of the bottom hinge from bottom of door leaf shall be equal to or less than that tested;
- d) where three hinges or distortion preventers are used, the distance between the bottom of the door leaf and centre restraint shall be equal to or greater than that tested.

#### A.3.3.4 Gaps

The maximum size of the primary gaps presented on page 12 is restricted to the following sizes in practice:

$$x = (a + b)/2 + 2 \text{ mm}$$

where

x is the maximum permitted gap size;

a is the maximum measured gap size;

b is the mean measured gap size.

The minimum size of the primary gaps may be reduced.

The permitted gap size may be different for different parts of the door or window.

## A.4 Asymmetrical Assemblies

### A.4.1 General

BS EN 1363-1 states that for separating elements required to be fire resisting from both sides, two test specimens shall be tested (one from each direction) unless the element is fully symmetrical, i.e. the construction of the doorset is identical on both sides of the centre line when viewed in plan (from above). However, in some cases it is possible to develop rules whereby the fire resistance of an asymmetrical door assembly tested in one direction can apply when the fire exposure is from the other direction. The possibility to develop such rules increases if the consideration is limited to certain types of door assembly and on the criteria being applicable (e.g. integrity only doors). The following rules represent the minimum level of common agreement which shall be followed. The rationale behind the rules is given in BS EN 1634-1:2014+A1:2018 § Annex C.

### A.4.2 Specific Rules

The rules governing the applicability of tests carried out in one direction to other directions are given in Table 10 and are based on the following premises:

- 1) that each of the door leaves are themselves of symmetrical construction with the exception of the edges (e.g. lock/leading edge and hinge edge or double rebated doors);
- 2) that any restraining/supporting elements of building hardware has been included in a test to BS EN 1634-1 when exposed in both directions so that they will retain their function when exposed to the heat of the test;
- 3) that there is no change in the number of leaves or the mode of operation (e.g. sliding, swinging, single action or double action);
- 4) that side, over and transom panels are excluded from Table 10 unless they are fully symmetrical.

Table 10 lists the type of door assembly for which rules can be generated and gives the direction in which it should be tested to cover the opposite direction. The separate columns for the integrity and insulation criteria reflect the different ability to make rules for integrity only doors as opposed to those which satisfy both criteria. A 'Yes' means that it is possible to identify the direction of test which covers the opposite direction. A 'No' indicates that it is not possible to identify the direction which will cover the opposite direction.

Table 10 - Type of doorset and direction to be tested to cover the opposite direction

Type of doorset	Direction to be tested to cover opposite direction	Integrity	Insulation	Radiation
Hinged or pivoted, timber leaf, timber frame	Opening into the furnace	yes	yes	yes
Hinged or pivoted, timber leaf, metal frame (no transom)	Opening into the furnace	yes	no	yes
Hinged, metal leaf, metal frame (not pivoted)	Opening away from Furnace	yes*	no	yes
Rolling shutter	Barrel and supporting components fixed on the face of the supporting wall on the fire side	yes	no	no
Sliding/folding	Sliding/folding supporting components fixed on the face of the supporting wall on the fire side	yes	no	no
Operable fabric curtains	Not possible to define a scenario			
*This only applies to doors without insulation in the core and with a movement restrictor at approximately mid-height on the hinge side.				

## A.5 Supporting Constructions

### A.5.1 General

The fire resistance of a door assembly tested in one form of standard supporting construction may or may not apply when it is mounted in other types of construction. Generally, the rigid and flexible types are not interchangeable and rules governing the direct application within each group are given in 13.5.2 to 13.5.4. However, in some cases it is possible for the result of a test on a particular type of door assembly tested in one form of standard supporting construction to be applicable to that door assembly when mounted in a different type of standard supporting construction. Specific rules governing the situation for hinged and pivoted door assemblies are given in 13.5.4. The rationale behind the rules is given in BS EN 1634-1:2014+A1:2018 § Annex C.

### A.5.2 Flexible Standard Supporting Constructions

The fire resistance of a door tested in one of the flexible standard supporting constructions specified in BS EN 1363-1:2020 can be applied to a door mounted in the same manner in a wall or partition which is of the board covered type with studs made from metal or timber. The fire resistance of the door is only applicable to a door mounted in a partition with a fire resistance equal to or greater than the partition in which it was tested.

The fire resistance of the partition shall have been established separately in a previous test.

### A.5.3 Specific Rules for Hinged or Pivoted Doorsets

- a) For timber door leaves hung in timber frames, the result of a test in a rigid standard supporting construction is applicable to that door assembly mounted in a flexible construction.
- b) For timber door leaves hung in timber frames, the result of a test in a flexible standard supporting construction is applicable to that door assembly mounted in a rigid construction.
- c) For timber door leaves hung in metal frames, the result of a test in a flexible standard supporting construction is applicable to that door assembly mounted in a rigid construction but not vice versa.
- d) For insulated metal door leaves hung in metal frames, there is no applicability of results in rigid standard supporting construction to flexible constructions or vice versa; to cover rigid and flexible types, tests shall be undertaken in each type of standard supporting construction.
- e) For uninsulated metal doors, the result of a test in a rigid standard supporting construction is applicable to that door assembly mounted in a flexible construction, but not vice versa.

The rules above assume that the fixing methods used in each type of supporting construction are appropriate to that construction. Thus for example in a), the test on the timber door leaf in a timber frame will have been carried out with appropriate fixings for timber frames in rigid constructions. The result is applicable to a timber door leaf in a timber frame mounted into a flexible construction with appropriate fixings for timber frames in flexible constructions.